

Wechat



Web



WhatsApp

**CKN<sup>®</sup> 中坤**

**CKN (Guangdong) Technology Co.,Ltd**

Add: No.8,Changxin Avenue,Jun'an Town,Shunde District,

Foshan City,Guangdong Province,China

Tel: +86-400 696 8877

E-mail: sales@cknlighting.com

www.ckn-ckn.com

Product details in this catalog are for reference only. Final specifications are subject to the physical product. Contact us for further details.



PRODUCT  
CATALOG

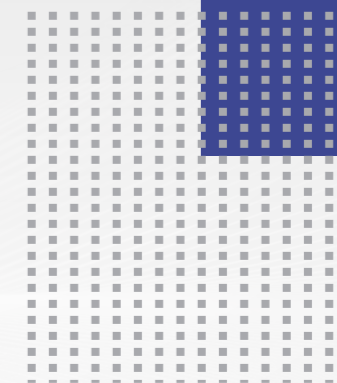
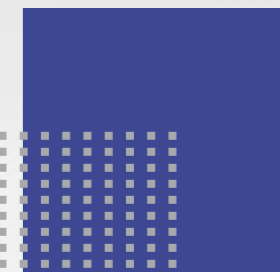

**CKN<sup>®</sup> 中坤**

LEADING BRAND OF  
COMMERCIAL  
LIGHTING





CKN<sup>®</sup> 中坤



LEADING BRAND OF  
COMMERCIAL LIGHTING

[www.ckn-ckn.com](http://www.ckn-ckn.com)

# COMPANY PROFILE

Ingenuity • Conscientiousness



## C K N F A C T O R Y

CKN (Guangdong) Technology Co., Ltd. was established in 2007 and is a customer-centric, technology-driven, and leading professional manufacturer of LED commercial lighting. Over the past 15 years, we have adhered to the principles of sincerity, professionalism, and gratitude in our business operations.

CKN factory is located in Foshan City, covering an area of 5000m<sup>2</sup>. The company has obtained ISO9001:2015 quality management system certification, and the products have been certified with CE, SAA, RoHS, CCC, and other qualifications, meeting different market standards both domestically and internationally.

During our ongoing development, CKN has established OEM/ODM partnerships with numerous well-known lighting brands in over a hundred countries, relying on our strong R&D, high-quality products, and comprehensive service system closely integrating pre-sales, in-sales, and after-sales services. Our aim is to provide the best lighting solutions for commercial spaces, enhance brand appeal, and elevate the overall experience of commercial environments. We have earned continuous praise and trust from the industry and our customers!

**2007**

Since

**5000m<sup>2</sup>**

Area

**9001:2015**

ISO

**CE/SAA/RoHS/CCC**

# CONTENTS

CKN (Guangdong) Technology Co., Ltd. was established in 2007 and is a customer-centric, technology-driven, and leading professional manufacturer of LED commercial lighting.

CE CCC SAA APPROVALIST  
RoHS ISO9001:2015

1

LED TRACK LIGHT



PARO/MILO/MIRRO/HEDY/FLORA/HANS/CUBE  
/LEILA/ECONO/LEDA/NORA/FOLD/RUBY/MITO  
/ZOOM/BBL/TRACK SYSTEM

~P001

2

LED SPOT LIGHT



LEGO/VELA/CIELO/SHADOW/KUDORA/MAMBA  
HERON/GRACE/TIDA/STAR/LUMI/NOVA

~P043

3

LED SCOOP LIGHT



ARES

~P073

4

LED PULL OUT LIGHT



LOKI

~P099

5

SURFACE MOUNTED DOWNLIGHT



UNO/BOX

~P111

6

LED GRILLE LIGHT



VEXA/BLED

~P115

7

LED DOWN LIGHT



WILL/SOVA/  
HALO/DORIS/  
LITA/CAVO

~P137

8

LED MAGNETIC LIGHT



NIKI

~P163

# LED Track light



# 1

## LED TRACK LIGHT

|               |                      |
|---------------|----------------------|
| PARO.....003  | LEDA.....003         |
| MILO.....003  | NORA.....003         |
| MIRRO.....003 | FOLD.....003         |
| HEDY.....003  | RUBY.....003         |
| FLORA.....003 | MITO.....003         |
| HANS.....003  | ZOOM.....003         |
| CUBE.....003  | BBL.....003          |
| LEILA.....003 | TRACK SYSTEM.....003 |
| ECONO.....003 |                      |



Power adjustable  
CCT adjustable

# PARO

## INTEGRATED LED TRACK LIGHT

PARA SERIES IS WITH CLASSIC DESIGN STRUCTURE WITH BUILT-IN DRIVER  
IT ADOPTS BRAND COB CHIP. 6063 ALUMINUM HEAT SINK PROVIDES HIGH THERMAL CONDUCTIVITY  
SECONDARY OPTICS WITH LENS AND REFLECTOR DELIVERS UNIFORM LIGHT OUTPUT

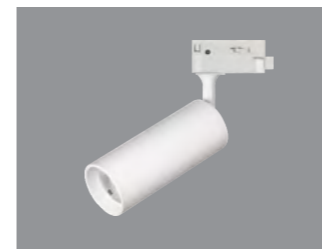

● **Swivel angle:**



● **CCT:**

2700K/3000K/4000K

● **Finish:**

White/Black/Grey

● **Mounting:**

Track mounted ( 1/2/3 phase)

● **Light source:**

COB LED  
Luminus/CREE/Bridgelux



| Model Code | Power | LED Current | Lumen (±5%) | Beam angle  | Input voltage         | CRI        | Dimming                  |  |
|------------|-------|-------------|-------------|-------------|-----------------------|------------|--------------------------|--|
| TL01A60    | 15W   | 350mA       | 1200 lm     | 15° 24° 38° | AC220-240V<br>50/60Hz | ≥90<br>≥97 | Triac<br>Dali<br>0/1-10V |  |
| TL01A70    | 20W   | 500mA       | 1800 lm     | 15° 24° 38° | AC220-240V<br>50/60Hz | ≥90<br>≥97 | Triac<br>Dali<br>0/1-10V |  |
| TL01A80    | 30W   | 700mA       | 2800 lm     | 15° 24° 38° | AC220-240V<br>50/60Hz | ≥90<br>≥97 | Triac<br>Dali<br>0/1-10V |  |

| Model Code | Power | LED Current | Lumen (±5%) | Beam angle  | Input voltage         | CRI        | Dimming                  |  |
|------------|-------|-------------|-------------|-------------|-----------------------|------------|--------------------------|--|
| TL01B60    | 15W   | 350mA       | 1200 lm     | 15° 24° 38° | AC220-240V<br>50/60Hz | ≥90<br>≥97 | Triac<br>Dali<br>0/1-10V |  |
| TL01B70    | 20W   | 500mA       | 1800 lm     | 15° 24° 38° | AC220-240V<br>50/60Hz | ≥90<br>≥97 | Triac<br>Dali<br>0/1-10V |  |
| TL01B80    | 30W   | 700mA       | 2800 lm     | 15° 24° 38° | AC220-240V<br>50/60Hz | ≥90<br>≥97 | Triac<br>Dali<br>0/1-10V |  |

● Power & CCT adjustable(dual DIP-switch on intrack adapter)

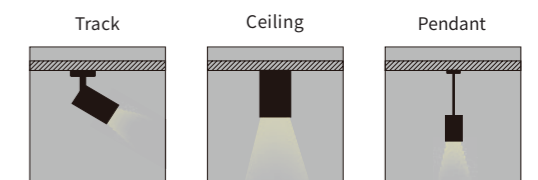
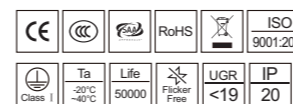



Power adjustable  
CCT adjustable

DIP switch for  
CCT adjustable

# MILO

## INTEGRATED LED TRACK LIGHT

MILO SERIES IS WITH BUILT-IN DRIVER AND ADOPTS BRAND COB CHIP  
DIE-CAST ALUMINUM HEAT SINK PROVIDES GREAT HEAT DISSIPATION  
3 DIFFERENT SIZES D60/D75/D90MM WITH OPTICAL ACCESSORY CHOICES OF CROSS LUVER HONEYCOMB ,WALL WASHER , BARN DOOR ECT



| Model Code | Power | LED Current | Lumen (±5%) | Beam angle      | Input voltage         | CRI        | Dimming                  |
|------------|-------|-------------|-------------|-----------------|-----------------------|------------|--------------------------|
| TL02A60    | 15W   | 350mA       | 1200 lm     | 15° 24° 38° 60° | AC220-240V<br>50/60Hz | ≥90<br>≥97 | Triac<br>Dali<br>0/1-10V |

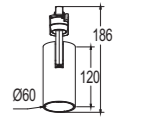

|         |     |       |         |                 |                       |            |                          |
|---------|-----|-------|---------|-----------------|-----------------------|------------|--------------------------|
| TL02A75 | 25W | 600mA | 2500 lm | 15° 24° 38° 60° | AC220-240V<br>50/60Hz | ≥90<br>≥97 | Triac<br>Dali<br>0/1-10V |
|---------|-----|-------|---------|-----------------|-----------------------|------------|--------------------------|

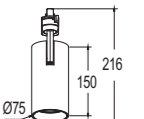

|         |     |       |         |                 |                       |            |                          |
|---------|-----|-------|---------|-----------------|-----------------------|------------|--------------------------|
| TL02A90 | 40W | 950mA | 4000 lm | 15° 24° 38° 60° | AC220-240V<br>50/60Hz | ≥90<br>≥97 | Triac<br>Dali<br>0/1-10V |
|---------|-----|-------|---------|-----------------|-----------------------|------------|--------------------------|

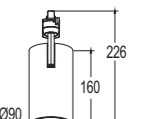

● DIP switch for CCT adjustable(on back)



| Model Code | Power | LED Current | Lumen (±5%) | Beam angle      | Input voltage         | CRI        | Dimming                  |
|------------|-------|-------------|-------------|-----------------|-----------------------|------------|--------------------------|
| TL02B60    | 15W   | 350mA       | 1200 lm     | 15° 24° 38° 60° | AC220-240V<br>50/60Hz | ≥90<br>≥97 | Triac<br>Dali<br>0/1-10V |

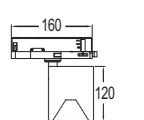

|         |     |       |         |                 |                       |            |                          |
|---------|-----|-------|---------|-----------------|-----------------------|------------|--------------------------|
| TL02B75 | 25W | 600mA | 2500 lm | 15° 24° 38° 60° | AC220-240V<br>50/60Hz | ≥90<br>≥97 | Triac<br>Dali<br>0/1-10V |
|---------|-----|-------|---------|-----------------|-----------------------|------------|--------------------------|

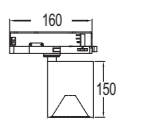

|         |     |       |         |                 |                       |            |                          |
|---------|-----|-------|---------|-----------------|-----------------------|------------|--------------------------|
| TL02B90 | 40W | 950mA | 4000 lm | 15° 24° 38° 60° | AC220-240V<br>50/60Hz | ≥90<br>≥97 | Triac<br>Dali<br>0/1-10V |
|---------|-----|-------|---------|-----------------|-----------------------|------------|--------------------------|

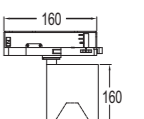

● Power & CCT adjustable(dual DIP-switch on intrack adapter)



● Swivel angle:

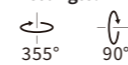

● CCT:  
2700K/3000K/4000K/5700K

● Finish:  
White/Black/Grey

● Mounting:  
Track mounted (1/2/3 phase)

● Light source:  
COB LED  
Luminus/CREE/Bridgelux



CCT adjustable      Track      Ceiling      Recessed





Power adjustable  
CCT adjustable

# MIRRO

## INTRACK LED TRACK LIGHT

HEDY SERIES IS WITH INTEGRATED DRIVER ADAPTER TO MAKE THE FITTING WITH LONGER LIFESPAN  
 IT ADOPTS ALUMINIUM REFLECTOR WITH EVEN LIGHTING DISTRIBUTION  
 DIE-CAST ALUMINIUM HEAT SINK PROVIDES GREAT HEAT DISSIPATION  
 3 DIFFERENT SIZES D90/D100/D110MM WITH OPTICAL ACCESSORY CHOICES OF CROSS LUVER HONEYCOMB ,WALL WASHER , BARN DOOR ECT.

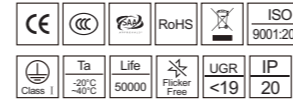

- **Swivel angle:**
- **CCT:**  
 2700K/3000K/3500K/4000K/5700K
- **Finish:**  
 White/Black/Grey
- **Mounting:**  
 Track mounted (1/2/3 phase)
- **Light source:**  
 COB LED  
 Luminus/CREE/Bridgelux

| Model Code | Power | LED Current | Lumen (±5%) | Beam angle      | Input voltage         | CRI        | Dimming                  |
|------------|-------|-------------|-------------|-----------------|-----------------------|------------|--------------------------|
| TL06B55    | 15W   | 350mA       | 1300 lm     | 15° 24° 38° 60° | AC220-240V<br>50/60Hz | ≥90<br>≥97 | Triac<br>Dali<br>0/1-10V |

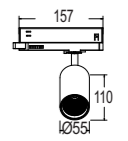

| Model Code | Power | LED Current | Lumen (±5%) | Beam angle      | Input voltage         | CRI        | Dimming                  |
|------------|-------|-------------|-------------|-----------------|-----------------------|------------|--------------------------|
| TL08B70    | 25W   | 600mA       | 2500 lm     | 15° 24° 38° 60° | AC220-240V<br>50/60Hz | ≥90<br>≥97 | Triac<br>Dali<br>0/1-10V |

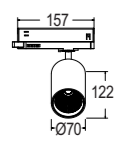

| Model Code | Power | LED Current | Lumen (±5%) | Beam angle      | Input voltage         | CRI        | Dimming                  |
|------------|-------|-------------|-------------|-----------------|-----------------------|------------|--------------------------|
| TL08B85    | 33W   | 800mA       | 3300 lm     | 15° 24° 38° 60° | AC220-240V<br>50/60Hz | ≥90<br>≥97 | Triac<br>Dali<br>0/1-10V |

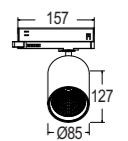

| Model Code | Power | LED Current | Lumen (±5%) | Beam angle      | Input voltage         | CRI        | Dimming                  |
|------------|-------|-------------|-------------|-----------------|-----------------------|------------|--------------------------|
| TL08B85A   | 38W   | 950mA       | 3800 lm     | 15° 24° 38° 60° | AC220-240V<br>50/60Hz | ≥90<br>≥97 | Triac<br>Dali<br>0/1-10V |

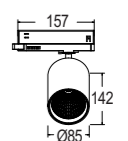

● Power & CCT adjustable(dual DIP-switch on intrack adapter)





# HEDY

## INTRACK LED TRACK LIGHT

HEDY SERIES IS WITH INTEGRATED DRIVER ADAPTER TO MAKE THE FITTING WITH LONGER LIFESPAN  
 IT ADOPTS ALUMINIUM REFLECTOR WITH EVEN LIGHTING DISTRIBUTION  
 DIE-CAST ALUMINIUM HEAT SINK PROVIDES GREAT HEAT DISSIPATION  
 3 DIFFERENT SIZES D90/D100/D110MM WITH OPTICAL ACCESSORY CHOICES OF CROSS LUVER, HONEYCOMB, WALL WASHER, BARN DOOR ECT.



| Model Code | Power | LED Current | Lumen (±5%) | Beam angle      | Input voltage         | CRI        | Dimming                  |
|------------|-------|-------------|-------------|-----------------|-----------------------|------------|--------------------------|
| TL03B90    | 20W   | 500mA       | 1800 lm     | 15° 24° 38° 60° | AC220-240V<br>50/60Hz | ≥90<br>≥97 | Triac<br>Dali<br>0/1-10V |

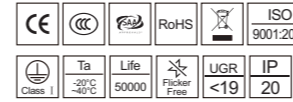
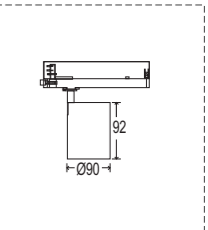

- **Swivel angle:**
- **CCT:**  
 2700K/3000K/3500K/4000K/5700K
- **Finish:**  
 White/Black/Grey
- **Mounting:**  
 Track mounted (1/2/3 phase)
- **Light source:**  
 COB LED  
 Luminus/CREE/Bridgelux

| Model Code | Power | LED Current | Lumen (±5%) | Beam angle      | Input voltage         | CRI        | Dimming                  |
|------------|-------|-------------|-------------|-----------------|-----------------------|------------|--------------------------|
| TL03B100   | 30W   | 700mA       | 3000 lm     | 15° 24° 38° 60° | AC220-240V<br>50/60Hz | ≥90<br>≥97 | Triac<br>Dali<br>0/1-10V |

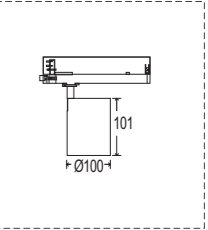

| Model Code | Power | LED Current | Lumen (±5%) | Beam angle      | Input voltage         | CRI        | Dimming                  |
|------------|-------|-------------|-------------|-----------------|-----------------------|------------|--------------------------|
| TL03B110   | 40W   | 950mA       | 4000 lm     | 15° 24° 38° 60° | AC220-240V<br>50/60Hz | ≥90<br>≥97 | Triac<br>Dali<br>0/1-10V |

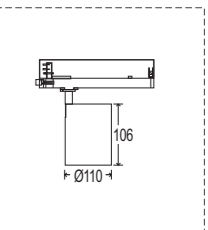

● Power & CCT adjustable(dual DIP-switch on intrack adapter)

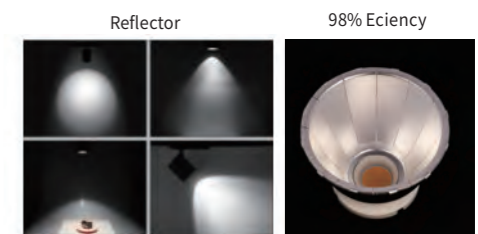



Power adjustable  
CCT adjustable



- **Swivel angle:**
- **CCT:**  
 2700K/3000K/3500K/4000K/5700K
- **Finish:**  
 White/Black/Grey
- **Mounting:**  
 Track mounted (1/2/3 phase)
- **Light source:**  
 COB LED  
 Luminus/CREE/Bridgelux

| Model Code | Power | LED Current | Lumen (±5%) | Beam angle      | Input voltage         | CRI        | Dimming                  |
|------------|-------|-------------|-------------|-----------------|-----------------------|------------|--------------------------|
| TL04A55    | 15W   | 350mA       | 1200 lm     | 15° 24° 38° 50° | AC220-240V<br>50/60Hz | ≥90<br>≥97 | Triac<br>Dali<br>0/1-10V |

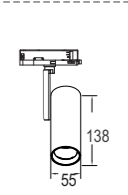

| Model Code | Power | LED Current | Lumen (±5%) | Beam angle      | Input voltage         | CRI        | Dimming                  |
|------------|-------|-------------|-------------|-----------------|-----------------------|------------|--------------------------|
| TL04A65    | 20W   | 500mA       | 1800 lm     | 15° 24° 38° 50° | AC220-240V<br>50/60Hz | ≥90<br>≥97 | Triac<br>Dali<br>0/1-10V |

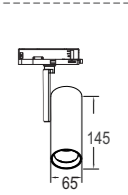

| Model Code | Power | LED Current | Lumen (±5%) | Beam angle      | Input voltage         | CRI        | Dimming                  |
|------------|-------|-------------|-------------|-----------------|-----------------------|------------|--------------------------|
| TL04A75    | 25W   | 600mA       | 2200 lm     | 15° 24° 38° 50° | AC220-240V<br>50/60Hz | ≥90<br>≥97 | Triac<br>Dali<br>0/1-10V |

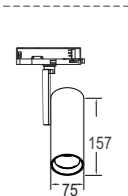

| Model Code | Power | LED Current | Lumen (±5%) | Beam angle      | Input voltage         | CRI        | Dimming                  |
|------------|-------|-------------|-------------|-----------------|-----------------------|------------|--------------------------|
| TL04A85    | 30W   | 750mA       | 2700 lm     | 15° 24° 38° 50° | AC220-240V<br>50/60Hz | ≥90<br>≥97 | Triac<br>Dali<br>0/1-10V |

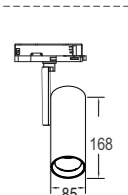

● Power & CCT adjustable(dual DIP-switch on intrack adapter)

# FLORA

## INTRACK LED TRACK LIGHT

FLORA SERIES IS WITH BUILT-IN DRIVER OR INTRACK ADAPTER ADOPTS TOP BRAND CHIPS  
 PROVIDING ADJUSTABLE LIGHTING ORIENTATION WITH 355° IN  
 HORIZONTAL DIRECTION AND 90° IN VERTICAL DIRECTION

Power & CCT adjustable

Black

Black



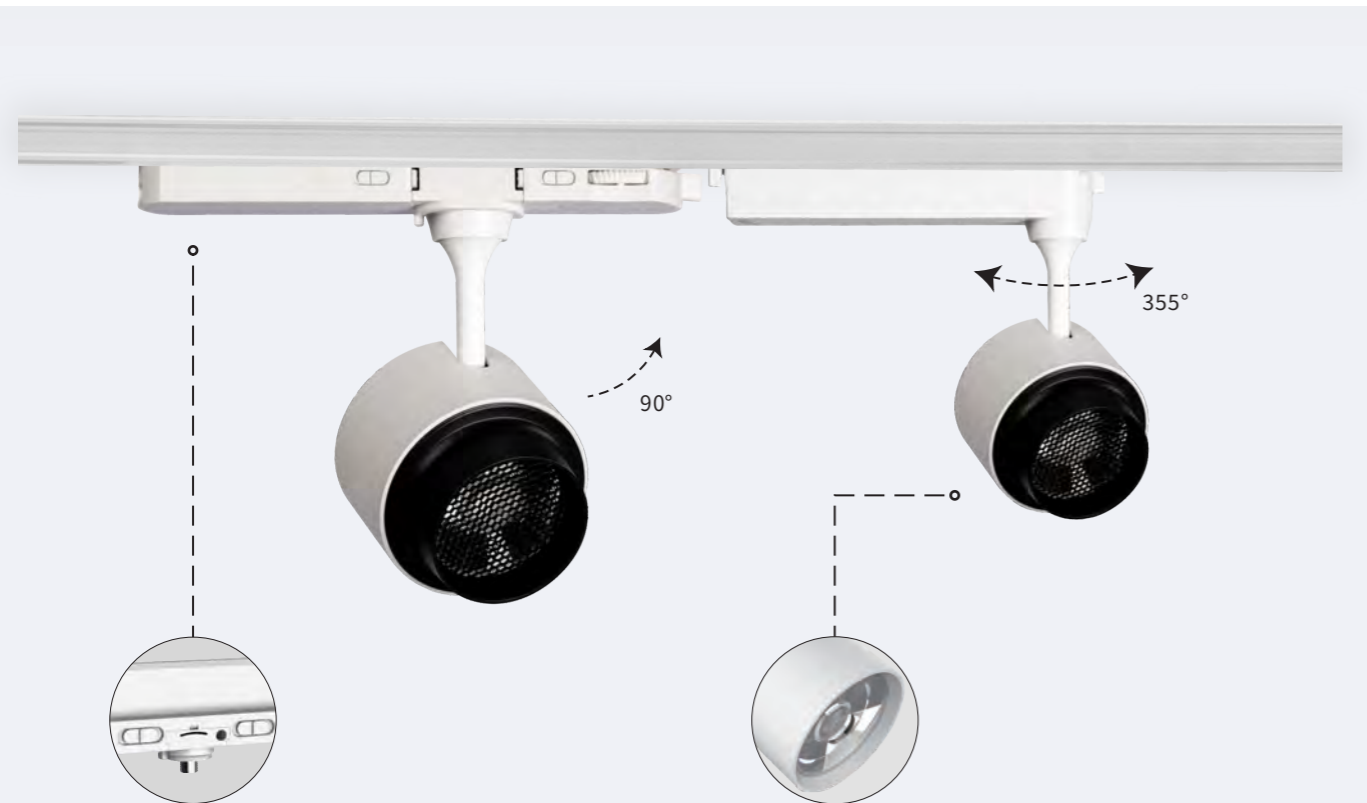

Power adjustable  
CCT adjustable

Available in flat cover

# HANS

## INTRACK SLIM TRACK LIGHT

HANS SERIES IS WITH INTRACK DRIVER ADAPTER AND BLACKENED SNOOT TO REDUCE GLARE EFFETIVELY  
SUPREME 6063 ALUMINUM HEAT SINK PROVIDES GREAT HEAT DISSIPATION



| Model Code | Power | LED Current | Lumen (±5%) | Beam angle  | Input voltage         | CRI        | Dimming                  |
|------------|-------|-------------|-------------|-------------|-----------------------|------------|--------------------------|
| TL20A85    | 15W   | 350mA       | 1200 lm     | 15° 24° 38° | AC220-240V<br>50/60Hz | ≥90<br>≥97 | Triac<br>Dali<br>0/1-10V |

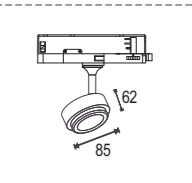

| Model Code | Power | LED Current | Lumen (±5%) | Beam angle  | Input voltage         | CRI        | Dimming                  |
|------------|-------|-------------|-------------|-------------|-----------------------|------------|--------------------------|
| TL20A110   | 20W   | 500mA       | 1800 lm     | 15° 24° 38° | AC220-240V<br>50/60Hz | ≥90<br>≥97 | Triac<br>Dali<br>0/1-10V |
| TL20B110   | 30W   | 700mA       | 2800 lm     | 15° 24° 38° | AC220-240V<br>50/60Hz | ≥90<br>≥97 | Triac<br>Dali<br>0/1-10V |
| TL20C75    | 18W   | 450mA       | 1600 lm     | 15° 24° 38° | AC220-240V<br>50/60Hz | ≥90<br>≥97 | Triac<br>Dali<br>0/1-10V |

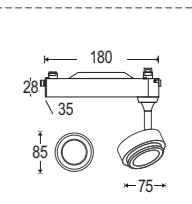

● Power & CCT adjustable(dual DIP-switch on intrack adapter)

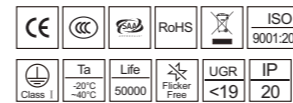

● Swivel angle:

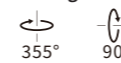

● CCT:

2700K/3000K/4000K/5700K

● Finish:

White/Black/Grey

● Mounting:

Track mounted (1/2/3 phase)

● Light source:

COB LED  
Luminus/CREE/Bridgelux

Power & CCT adjustable

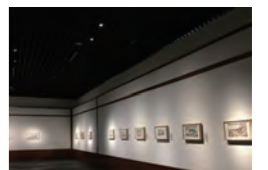



# CUBE

## SQUARE TRACK LIGHT

CUBE SERIES ADOPTS BRAND COB LED AND DIE-CAST ALUMINIUM HOUSING PROVIDES EXCELLENT HEAT DISSIPATION  
SEPCIAL DESIGN 1 HEAD OR 2 HEADS IN SQUARE APPEARANCE TO DELIVERS UNIFORM LIGHT SPOT



| Model Code | Power | LED Current | Lumen (±5%) | Beam angle | Input voltage | CRI | Dimming |
|------------|-------|-------------|-------------|------------|---------------|-----|---------|
|------------|-------|-------------|-------------|------------|---------------|-----|---------|

|         |                 |       |         |     |                       |            |                          |
|---------|-----------------|-------|---------|-----|-----------------------|------------|--------------------------|
| TL05S90 | 32W<br>(8W x 4) | 800mA | 2800 lm | 60° | AC220-240V<br>50/60Hz | ≥90<br>≥97 | Triac<br>Dali<br>0/1-10V |
|---------|-----------------|-------|---------|-----|-----------------------|------------|--------------------------|

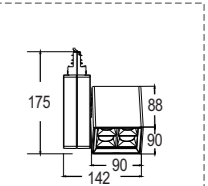

|          |        |       |         |     |                       |            |                          |
|----------|--------|-------|---------|-----|-----------------------|------------|--------------------------|
| TL05S902 | 32W x2 | 800mA | 5600 lm | 60° | AC220-240V<br>50/60Hz | ≥90<br>≥97 | Triac<br>Dali<br>0/1-10V |
|----------|--------|-------|---------|-----|-----------------------|------------|--------------------------|

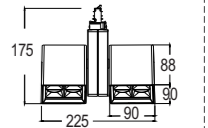

| Model Code | Power | LED Current | Lumen (±5%) | Beam angle | Input voltage | CRI | Dimming |
|------------|-------|-------------|-------------|------------|---------------|-----|---------|
|------------|-------|-------------|-------------|------------|---------------|-----|---------|

|         |     |       |         |             |                       |            |                          |
|---------|-----|-------|---------|-------------|-----------------------|------------|--------------------------|
| TL07S95 | 40W | 950mA | 3800 lm | 15° 25° 35° | AC220-240V<br>50/60Hz | ≥90<br>≥97 | Triac<br>Dali<br>0/1-10V |
|---------|-----|-------|---------|-------------|-----------------------|------------|--------------------------|

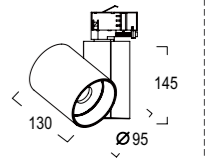

| Model Code | Power | LED Current | Lumen (±5%) | Beam angle | Input voltage | CRI | Dimming |
|------------|-------|-------------|-------------|------------|---------------|-----|---------|
|------------|-------|-------------|-------------|------------|---------------|-----|---------|

|         |     |       |         |             |                       |            |                          |
|---------|-----|-------|---------|-------------|-----------------------|------------|--------------------------|
| TL07R71 | 35W | 850mA | 3200 lm | 15° 25° 35° | AC220-240V<br>50/60Hz | ≥90<br>≥97 | Triac<br>Dali<br>0/1-10V |
|---------|-----|-------|---------|-------------|-----------------------|------------|--------------------------|

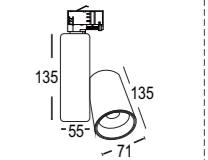

● Swivel angle:



● CCT:

2700K/3000K/4000K/5700K

● Finish:

White/Black/Grey

● Mounting:

Track mounted (1/2/3 phase)

● Light source:

COB LED  
Luminus/CREE/Bridgelux



# LEILA

## INTEGRATED LED TRACK LIGHT

LEILA SERIES IS WITH BUILT-IN DRIVER AND ADOPTS BRAND COB CHIP  
 DIE-CAST ALUMINUM HEAT SINK PROVIDES GREAT HEAT DISSIPATION  
 3 DIFFERENT SIZES WITH OPTICAL ACCESSORY CHOICES OF CROSS LUVER, HONEYCOMB, WALL WASHER, BARN DOOR ECT.



| Model Code | Power | LED Current | Lumen (±5%) | Beam angle  | Input voltage         | CRI        | Dimming                  |
|------------|-------|-------------|-------------|-------------|-----------------------|------------|--------------------------|
| TL08A65    | 15W   | 350mA       | 1200 lm     | 15° 24° 38° | AC220-240V<br>50/60Hz | ≥90<br>≥97 | Triac<br>Dali<br>0/1-10V |

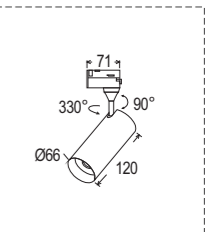

- **Swivel angle:**
- **CCT:**  
 2700K/3000K/3500K/4000K/5700K
- **Finish:**  
 White/Black/Grey
- **Mounting:**  
 Track mounted (1/2/3 phase)
- **Light source:**  
 COB LED  
 Luminus/CREE/Bridgelux

| Model Code | Power | LED Current | Lumen (±5%) | Beam angle  | Input voltage         | CRI        | Dimming                  |
|------------|-------|-------------|-------------|-------------|-----------------------|------------|--------------------------|
| TL08A70    | 25W   | 600mA       | 2500 lm     | 15° 24° 38° | AC220-240V<br>50/60Hz | ≥90<br>≥97 | Triac<br>Dali<br>0/1-10V |

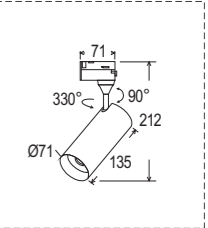

| Model Code | Power | LED Current | Lumen (±5%) | Beam angle  | Input voltage         | CRI        | Dimming                  |
|------------|-------|-------------|-------------|-------------|-----------------------|------------|--------------------------|
| TL08A80    | 30W   | 700mA       | 2800 lm     | 15° 24° 38° | AC220-240V<br>50/60Hz | ≥90<br>≥97 | Triac<br>Dali<br>0/1-10V |

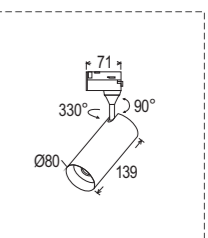

● Power & CCT adjustable(dual DIP-switch on intrack adapter)



Power & CCT adjustable

2/4 Wire





Power adjustable  
CCT adjustable

# ECONO

## INTRACK LED TRACK LIGHT

ECONO SERIES IS WITH BUILT-IN WITH BUILT-IN DRIVER OR INTRACK ADAPTER ADOPTS TOP BRAND CHIPS  
6063 ALUMINUM HEAT SINK PROVIDES GREAT HEAT DISSIPATION  
DEEP SNOOT TO REDUCE GLARE EFFECTIVELY

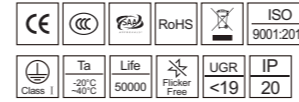

- **Swivel angle:**  
355° 90°
- **CCT:**  
2700K/3000K/4000K/5700K
- **Finish:**  
White/Black/Grey
- **Mounting:**  
Track mounted (1/2/3 phase)
- **Light source:**  
COB LED  
Luminus/CREE/Bridgelux

| Model Code | Power | LED Current | Lumen (±5%) | Beam angle      | Input voltage         | CRI        | Dimming                  |  |
|------------|-------|-------------|-------------|-----------------|-----------------------|------------|--------------------------|--|
| TL19BA55   | 15W   | 350mA       | 1350lm      | 15° 24° 36° 60° | AC220-240V<br>50/60Hz | ≥90<br>≥97 | Triac<br>Dali<br>0/1-10V |  |
| TL19BB55   | 25W   | 600mA       | 2250lm      | 15° 24° 36° 60° | AC220-240V<br>50/60Hz | ≥90<br>≥97 | Triac<br>Dali<br>0/1-10V |  |
| TL19BA65   | 20W   | 500mA       | 1800lm      | 15° 24° 36° 60° | AC220-240V<br>50/60Hz | ≥90<br>≥97 | Triac<br>Dali<br>0/1-10V |  |
| TL19BB65   | 25W   | 600mA       | 2250lm      | 15° 24° 36° 60° | AC220-240V<br>50/60Hz | ≥90<br>≥97 | Triac<br>Dali<br>0/1-10V |  |
| TL19BA75   | 30W   | 750mA       | 2940lm      | 15° 24° 36° 60° | AC220-240V<br>50/60Hz | ≥90<br>≥97 | Triac<br>Dali<br>0/1-10V |  |
| TL19BB75   | 35W   | 850mA       | 3430lm      | 15° 24° 36° 60° | AC220-240V<br>50/60Hz | ≥90<br>≥97 | Triac<br>Dali<br>0/1-10V |  |
| TL19BA85   | 35W   | 850mA       | 3500lm      | 15° 24° 36° 60° | AC220-240V<br>50/60Hz | ≥90<br>≥97 | Triac<br>Dali<br>0/1-10V |  |
| TL19BB85   | 40W   | 950mA       | 4000lm      | 15° 24° 36° 60° | AC220-240V<br>50/60Hz | ≥90<br>≥97 | Triac<br>Dali<br>0/1-10V |  |

● Power & CCT adjustable(dual DIP-switch on intrack adapter)



Power & CCT adjustable



Power adjustable  
CCT adjustable

# LEDA

## TRACK LIGHT WITH DRIVER BOX

LEDA SERIES IS WITH EXTERNAL DRIVER  
IT ADOPTS ANTI-GLARE PC LENS WITH GREAT LIGHTING DISTRIBUTION AND BRAND COB LED  
DIE-CAST ALUMINUM HEAT SINK PROVIDES GREAT HEAT DISSIPATION. AVAILABLE IN DALI DIMMING



- **Swivel angle:**  
355° 90°
- **CCT:**  
2700K/3000K/4000K/5700K
- **Finish:**  
White/Black/Grey
- **Mounting:**  
Track mounted (1/2/3 phase)
- **Light source:**  
COB LED  
Luminus/CREE/Bridgelux

| Model Code | Power | LED Current | Lumen (±5%) | Beam angle  | Input voltage         | CRI        | Dimming                  |
|------------|-------|-------------|-------------|-------------|-----------------------|------------|--------------------------|
| TL09CA45   | 9W    | 200mA       | 720 lm      | 15° 24° 38° | AC220-240V<br>50/60Hz | ≥90<br>≥97 | Triac<br>Dali<br>0/1-10V |
| TL09CB45   | 15W   | 350mA       | 1200 lm     | 15° 24° 38° | AC220-240V<br>50/60Hz | ≥90<br>≥97 | Triac<br>Dali<br>0/1-10V |
| TL09CA55   | 15W   | 350mA       | 1200 lm     | 15° 24° 38° | AC220-240V<br>50/60Hz | ≥90<br>≥97 | Triac<br>Dali<br>0/1-10V |
| TL09CB55   | 20W   | 500mA       | 1800 lm     | 15° 24° 38° | AC220-240V<br>50/60Hz | ≥90<br>≥97 | Triac<br>Dali<br>0/1-10V |
| TL09C66    | 25W   | 600mA       | 2500 lm     | 15° 24° 38° | AC220-240V<br>50/60Hz | ≥90<br>≥97 | Triac<br>Dali<br>0/1-10V |

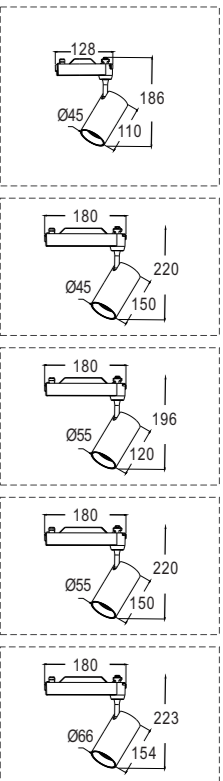

● Power & CCT adjustable(dual DIP-switch on intrack adapter)



| Model Code | Power | LED Current | Lumen (±5%) | Beam angle  | Input voltage         | CRI        | Dimming                  |
|------------|-------|-------------|-------------|-------------|-----------------------|------------|--------------------------|
| TL10C70    | 30W   | 750mA       | 2800 lm     | 15° 24° 38° | AC220-240V<br>50/60Hz | ≥90<br>≥97 | Triac<br>Dali<br>0/1-10V |
| TL10C75    | 30W   | 750mA       | 2800 lm     | 15° 24° 38° | AC220-240V<br>50/60Hz | ≥90<br>≥97 | Triac<br>Dali<br>0/1-10V |
| TL10C80    | 35W   | 850mA       | 3500 lm     | 15° 24° 38° | AC220-240V<br>50/60Hz | ≥90<br>≥97 | Triac<br>Dali<br>0/1-10V |
| TL10C85    | 40W   | 950mA       | 4000 lm     | 15° 24° 38° | AC220-240V<br>50/60Hz | ≥90<br>≥97 | Triac<br>Dali<br>0/1-10V |

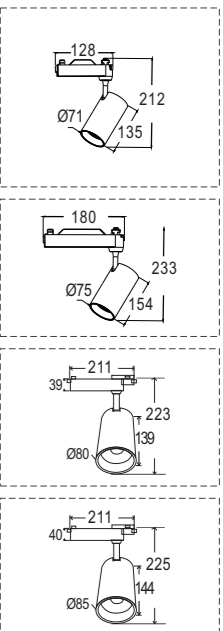

● Power & CCT adjustable(dual DIP-switch on intrack adapter)

Power & CCT adjustable





L=119mm

L=195mm

# NORA

## LINEAR LED TRACK LIGHT

NORA SERIES OF LINEAR TRACK LIGHT WITH LOUVER LENS DESIGN  
 IT'S WIDELY USED AS WALL WASHER SPOT TRACK LIGHT. LOUVERLENS MAKE IT ANTI-GLARE  
 DIE-CAST ALUMINUM HEAT SINK PROVIDES GREAT HEAT DISSIPATION  
 ADJUSTABLE LIGHTING ORIENTATION WITH 350° IN HORIZONTAL DIRECTION AND 90° IN VERTICAL DIRECTION



| Model Code | Power | LED Current | Lumen (±5%) | Beam angle  | Input voltage         | CRI        | Dimming                  |
|------------|-------|-------------|-------------|-------------|-----------------------|------------|--------------------------|
| TL11C120   | 20W   | 500mA       | 2800 lm     | 15° 24° 38° | AC220-240V<br>50/60Hz | ≥90<br>≥97 | Triac<br>Dali<br>0/1-10V |

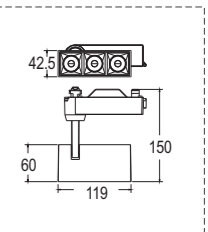

| Model Code | Power | LED Current | Lumen (±5%) | Beam angle  | Input voltage         | CRI        | Dimming                  |
|------------|-------|-------------|-------------|-------------|-----------------------|------------|--------------------------|
| TL11C200   | 35W   | 850mA       | 3200 lm     | 15° 24° 38° | AC220-240V<br>50/60Hz | ≥90<br>≥97 | Triac<br>Dali<br>0/1-10V |

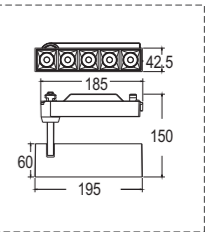

| Model Code | Power | LED Current | Lumen (±5%) | Beam angle | Input voltage         | CRI        | Dimming                  |
|------------|-------|-------------|-------------|------------|-----------------------|------------|--------------------------|
| TL12C120   | 25W   | 600mA       | 2400 lm     | Aysmmetric | AC220-240V<br>50/60Hz | ≥90<br>≥97 | Triac<br>Dali<br>0/1-10V |

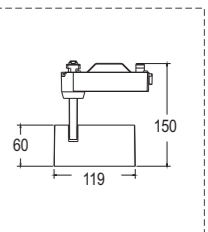

| Model Code | Power | LED Current | Lumen (±5%) | Beam angle | Input voltage         | CRI        | Dimming                  |
|------------|-------|-------------|-------------|------------|-----------------------|------------|--------------------------|
| TL12C200   | 35W   | 850mA       | 3200 lm     | Aysmmetric | AC220-240V<br>50/60Hz | ≥90<br>≥97 | Triac<br>Dali<br>0/1-10V |

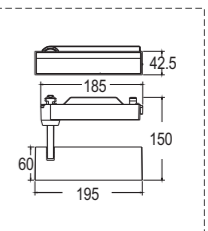

● Swivel angle:

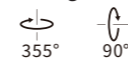

● CCT:

2700K/3000K/3500K/4000K/5000K

● Finish:

White/Black/Grey

● Mounting:

Track mounted (1/2/3 phase)

● Light source:

COB LED  
Luminus/CREE/Bridgelux





# FOLD

## FOLD TRACK LIGHT

FITTING HEAD CAN BE FIXED AT ANY POSITION .  
DIFFERENT SIZE FOR OPTION  
EFFECTIVELY PREVENT GLARE AND CREATE A COMFORTABLE LIGHT ENVIRONMENT



| Model Code | Power | LED Current | Lumen (±5%) | Beam angle  | Input voltage         | CRI        | Dimming                  |
|------------|-------|-------------|-------------|-------------|-----------------------|------------|--------------------------|
| TL13C65    | 25W   | 600mA       | 2200 lm     | 15° 24° 38° | AC220-240V<br>50/60Hz | ≥90<br>≥97 | Triac<br>Dali<br>0/1-10V |

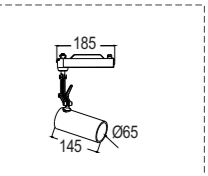

| Model Code | Power | LED Current | Lumen (±5%) | Beam angle  | Input voltage         | CRI        | Dimming                  |
|------------|-------|-------------|-------------|-------------|-----------------------|------------|--------------------------|
| TL14C55    | 15W   | 350mA       | 1200 lm     | 15° 24° 38° | AC220-240V<br>50/60Hz | ≥90<br>≥97 | Triac<br>Dali<br>0/1-10V |

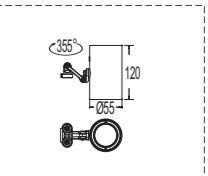

|         |     |       |         |             |                       |            |                          |
|---------|-----|-------|---------|-------------|-----------------------|------------|--------------------------|
| TL14C65 | 25W | 600mA | 2500 lm | 15° 24° 38° | AC220-240V<br>50/60Hz | ≥90<br>≥97 | Triac<br>Dali<br>0/1-10V |
|---------|-----|-------|---------|-------------|-----------------------|------------|--------------------------|

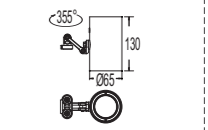

|         |     |       |         |             |                       |            |                          |
|---------|-----|-------|---------|-------------|-----------------------|------------|--------------------------|
| TL14C75 | 30W | 750mA | 2800 lm | 15° 24° 38° | AC220-240V<br>50/60Hz | ≥90<br>≥97 | Triac<br>Dali<br>0/1-10V |
|---------|-----|-------|---------|-------------|-----------------------|------------|--------------------------|

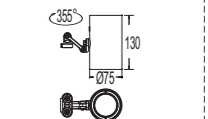

|         |     |       |         |             |                       |            |                          |
|---------|-----|-------|---------|-------------|-----------------------|------------|--------------------------|
| TL14C85 | 40W | 950mA | 4000 lm | 15° 24° 38° | AC220-240V<br>50/60Hz | ≥90<br>≥97 | Triac<br>Dali<br>0/1-10V |
|---------|-----|-------|---------|-------------|-----------------------|------------|--------------------------|

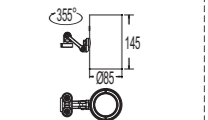

- **Swivel angle:**  
355° 90°
- **CCT:**  
2700K/3000K/3500K/4000K/5700K
- **Finish:**  
White/Black/Grey
- **Mounting:**  
Track mounted (1/2/3 phase)
- **Light source:**  
COB LED  
Luminus/CREE/Bridgelux

Track mounted



Recessed buckle side-mounting





# RUBY

## COB WALL WASHER

40W CAN MEET WITH LUX REQUIREMENT IN 5M HEIGHT  
 PROFESSIONAL ALU REFLECTOR DESIGN ENSURES WALL WASHING IS EVEN WITHOUT SPOT SHADOW  
 HORIZONTAL & VERTICAL ADJUSTABLE TO MEET WITH DIFFERENT APPLICATIONS



| Model Code | Power | LED Current | Lumen (±5%) | Beam angle | Input voltage         | CRI        | Dimming                  |
|------------|-------|-------------|-------------|------------|-----------------------|------------|--------------------------|
| TL15SW     | 40W   | 1200mA      | 3500 lm     | 90°        | AC220-240V<br>50/60Hz | ≥90<br>≥97 | Triac<br>Dali<br>0/1-10V |

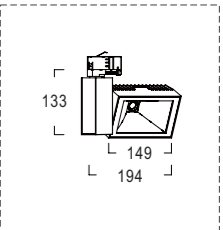

- **Swivel angle:**
- **CCT:**  
 2700K/3000K/3500K/4000K/5700K
- **Finish:**  
 White/Black
- **Mounting:**  
 Track mounted (1/2/3 phase)
- **Light source:**  
 COB LED  
 Luminus/CREE/Bridgelux



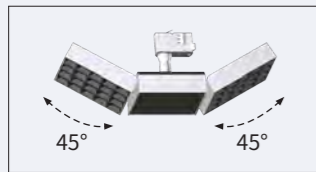

Office lighting

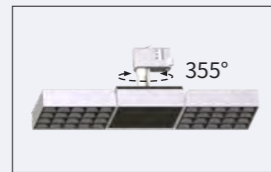

Office lighting



Retail lighting

# MITO

## MULTI-FUNCTIONAL TRACK LIGHT

SWING UP TO 45°  
 HORIZONTAL ADJUSTABLE 355°  
 SWING BACK AND FORTH 180°

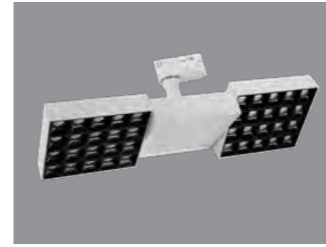

| Model Code | Power   | LED Current | Lumen (±5%) | Beam angle  | Input voltage         | CRI        | Dimming                  |
|------------|---------|-------------|-------------|-------------|-----------------------|------------|--------------------------|
| TL16SW2    | 35W+35W | 850mA       | 6000 lm     | 15° 30° 45° | AC220-240V<br>50/60Hz | ≥90<br>≥97 | Triac<br>Dali<br>0/1-10V |

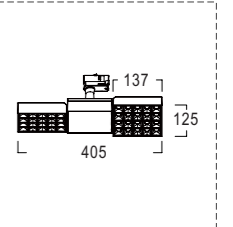

● **Swivel angle:**



● **CCT:**

2700K/3000K/3500K/4000K/5000K

● **Finish:**

White/Black/Grey

● **Mounting:**

Track mounted (1/2/3 phase)

● **Light source:**

COB LED  
 Luminus/CREE/Bridgelux





ZOOM 20° ~ 50°

# ZOOM

## ZOOM LED TRACK LIGHT

ZOOM SERIES IS WITH INTRACK ADAPTER AND ADOPTS TOP BRAND CHIPS  
 PROVIDING ADJUSTABLE LIGHTING ORIENTATION WITH 355° IN HORIZONTAL DIRECTION AND 90° IN VERTICAL DIRECTION  
 THE ZOOM DESIGN CAN HELP CHANGE THE LIGHTING EFFECT FROM A NARROW ANGLE TO A WIDER ANGLE  
 BY ADJUSTING THE DISTANCE BETWEEN THE LENS AND COB CHIP WITHOUT CHANGING THE OPTICS



- **Swivel angle:**
- **CCT:**  
 2700K/3000K/3500K/4000K/5700K
- **Finish:**  
 White/Black
- **Mounting:**  
 Track mounted (1/2/3 phase)
- **Light source:**  
 COB LED  
 Luminus/CREE/Bridgelux

| Model Code | Power | LED Current | Lumen (±5%) | Beam angle | Input voltage         | CRI        | Dimming                  |
|------------|-------|-------------|-------------|------------|-----------------------|------------|--------------------------|
| TL17B60Z   | 10W   | 250mA       | 600 lm      | 20° ~ 50°  | AC220-240V<br>50/60Hz | ≥90<br>≥97 | Triac<br>Dali<br>0/1-10V |

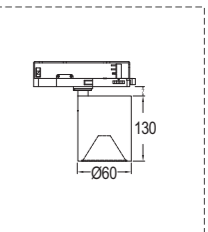

| Model Code | Power | LED Current | Lumen (±5%) | Beam angle | Input voltage         | CRI        | Dimming                  |
|------------|-------|-------------|-------------|------------|-----------------------|------------|--------------------------|
| TL17B70Z   | 20W   | 500mA       | 1200 lm     | 20° ~ 50°  | AC220-240V<br>50/60Hz | ≥90<br>≥97 | Triac<br>Dali<br>0/1-10V |

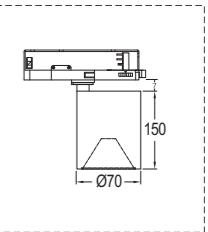

| Model Code | Power | LED Current | Lumen (±5%) | Beam angle | Input voltage         | CRI        | Dimming                  |
|------------|-------|-------------|-------------|------------|-----------------------|------------|--------------------------|
| TL17B80Z   | 30W   | 750mA       | 1800 lm     | 20° ~ 50°  | AC220-240V<br>50/60Hz | ≥90<br>≥97 | Triac<br>Dali<br>0/1-10V |

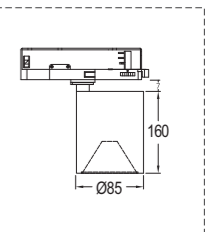

0/1-10V dim + 3CCT



Zoom Beam Angle Range

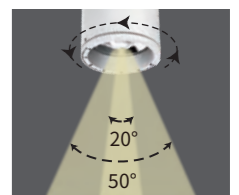



# ZOOM

## ZOOM LED TRACK LIGHT

ZOOM SERIES IS WITH BUILT-IN DRIVER AND THE ZOOM DESIGN CAN HELP CHANGE THE LIGHTING EFFECT FROM A NARROW ANGLE TO A WIDER ANGLE BY ADJUSTING THE DISTANCE BETWEEN THE LENS AND COB CHIP WITHOUT CHANGING THE OPTICS, 0/1-10V DIMMER DIP SWITCH ON THE BODY BACK FOR EASY DIMMING.



| Model Code | Power | LED Current | Lumen (±5%) | Beam angle | Input voltage         | CRI        | Dimming                  |
|------------|-------|-------------|-------------|------------|-----------------------|------------|--------------------------|
| TL18A70Z   | 15W   | 350mA       | 750 lm      | 20° ~ 60°  | AC220-240V<br>50/60Hz | ≥90<br>≥97 | Triac<br>Dali<br>0/1-10V |

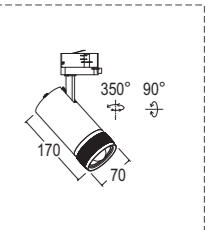

- **Swivel angle:**
- **CCT:**  
2700K/3000K/3500K/4000K/5700K
- **Finish:**  
White/Black
- **Mounting:**  
Track mounted (1/2/3 phase)
- **Light source:**  
COB LED  
Luminus/CREE/Bridgelux

| Model Code | Power | LED Current | Lumen (±5%) | Beam angle | Input voltage         | CRI        | Dimming                  |
|------------|-------|-------------|-------------|------------|-----------------------|------------|--------------------------|
| TL18A80Z   | 25W   | 600mA       | 1400 lm     | 20° ~ 60°  | AC220-240V<br>50/60Hz | ≥90<br>≥97 | Triac<br>Dali<br>0/1-10V |

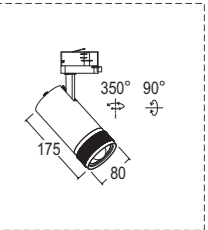

| Model Code | Power | LED Current | Lumen (±5%) | Beam angle | Input voltage         | CRI        | Dimming                  |
|------------|-------|-------------|-------------|------------|-----------------------|------------|--------------------------|
| TL18A95Z   | 35W   | 850mA       | 2200 lm     | 20° ~ 60°  | AC220-240V<br>50/60Hz | ≥90<br>≥97 | Triac<br>Dali<br>0/1-10V |

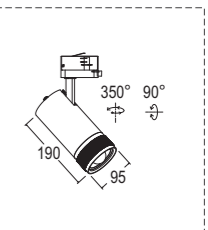





Soft light filter   Dimming filter   Color filter

Polarizing filter   Graduated filter   UV filter

# BBL

## FRAMING & ZOOM TRACK LIGHT

THE BBL SERIES IS DESIGNED WITH MULTIPLE HD LENS AND IS EQUIPPED WITH HIGH PRECISION VARIABLE OPTICAL BRAKES THAT CAN ACCURATELY CUT THE LIGHT SPOT IN ANY SHAPE AND CAN BE ACHIEVED SPOT WITHOUT ANY BURR EFFECT. SPECIALLY APPLIED IN MUSEUMS AND GALLERIES IN ADDITION ,THIS RANGE IS EQUIPPED WITH ZOOM HEAD TO HAVE THE LIGHT SPOT TO BE ADJUSTED IN ANY SIZE /SHARPNESS/SHAPE



0/1-10V dim+3CCT   Track   Ceiling   Recessed

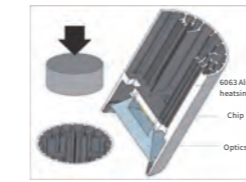

① Integrated cold forging heatsink

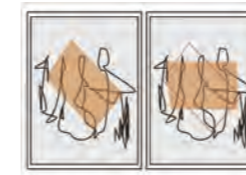

② Releasing the screw allows the lens to rotate 360° to achieve a light spot.

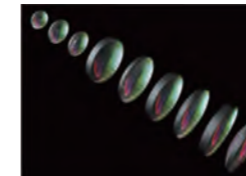

③ High-definition optical lens

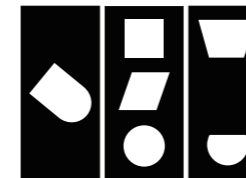

④ Optical-grade variable aperture



⑤ Multilayer dry damping

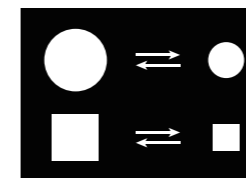

Biggest angle   Smallest angle

⑥ Multilayer dry damping

CUT LIGHT + INTELLIGENT CONTROL



Shapeable & zoomable tracklight

A combination of high-quality coated lenses, High light output, uniform light output, small distortion. Linear zoom range is large, Light spot cutoff good, no blue edge.

Zoom Beam Angle Range

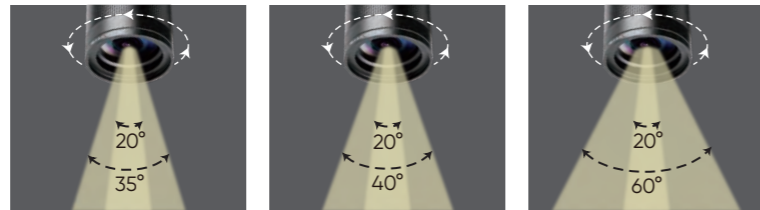

CUT LIGHT

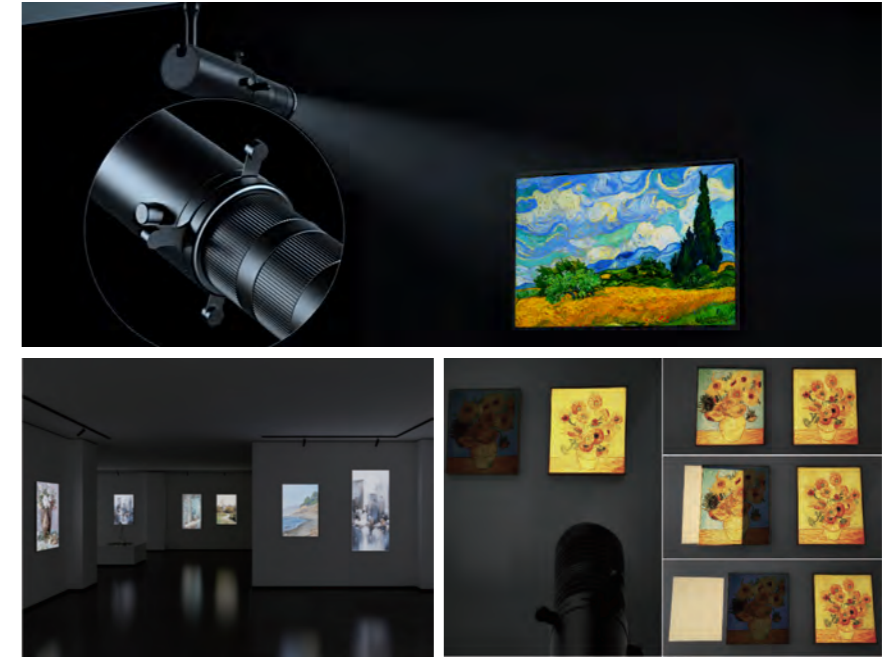

ZOOM



### Industrial-grade optical filter

Match with various industrial-grade optical filters and customized for special and ultra-narrow band optical filters. Some filter functions can be combined, such as HDUV + color filters, HDUV + diffuser filters, and so on.

#### Color filter

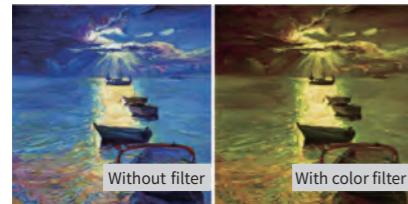

The light color can be adjusted according to the needs.

#### ND filter

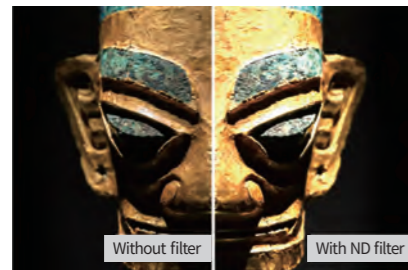

the lux can be reduced to below 75 lux, typically used for the original works.

#### UV filter



Effectively filter UV rays, performing exceptionally well in the illumination of artifacts and silk products

#### GND filter



A gradient filter is used to change the light ratio entering the lens, such as when illuminating an object from a slanted angle. Using a gradient filter ensures even illumination of the object without abrupt transitions

#### CPL filter



Eliminate surface reflections from objects, allowing them to maintain their original appearance even in overly bright environments.

#### Other filter



Customize various filters for specific spectral bands according to the actual needs, suitable for various specialized applications. eg. crystal cutting, high-precision PCB printing, and pharmaceutical sorting



| Model Code | Power | LED Current | Lumen (±5%) | Beam angle | Input voltage         | CRI        | Dimming                  |
|------------|-------|-------------|-------------|------------|-----------------------|------------|--------------------------|
| ZS4510     | 10W   | 250mA       | 450 lm      | 20° ~ 35°  | AC220-240V<br>50/60Hz | ≥90<br>≥97 | Triac<br>Dali<br>0/1-10V |

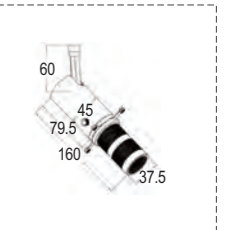

| Model Code | Power | LED Current | Lumen (±5%) | Beam angle | Input voltage         | CRI        | Dimming                  |
|------------|-------|-------------|-------------|------------|-----------------------|------------|--------------------------|
| ZS2530     | 20W   | 500mA       | 1125 lm     | 20° ~ 35°  | AC220-240V<br>50/60Hz | ≥90<br>≥97 | Triac<br>Dali<br>0/1-10V |

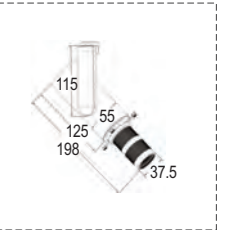

| Model Code | Power | LED Current | Lumen (±5%) | Beam angle | Input voltage         | CRI        | Dimming                  |
|------------|-------|-------------|-------------|------------|-----------------------|------------|--------------------------|
| ZS2540     | 30W   | 750mA       | 1750 lm     | 20° ~ 40°  | AC220-240V<br>50/60Hz | ≥90<br>≥97 | Triac<br>Dali<br>0/1-10V |

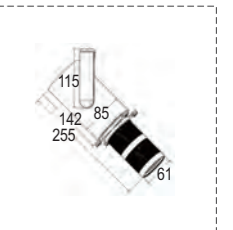

| Model Code | Power | LED Current | Lumen (±5%) | Beam angle | Input voltage         | CRI        | Dimming                  |
|------------|-------|-------------|-------------|------------|-----------------------|------------|--------------------------|
| ZS2560     | 30W   | 750mA       | 1750 lm     | 50° ~ 60°  | AC220-240V<br>50/60Hz | ≥90<br>≥97 | Triac<br>Dali<br>0/1-10V |

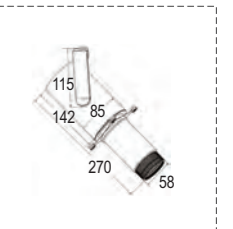

● Swivel angle:



- CCT: 2700K/3000K/4000K/5700K
- Finish: White/Black
- Mounting: Track mounted (1/2/3 phase)
- Light source: COB LED Luminus/Bridgelux

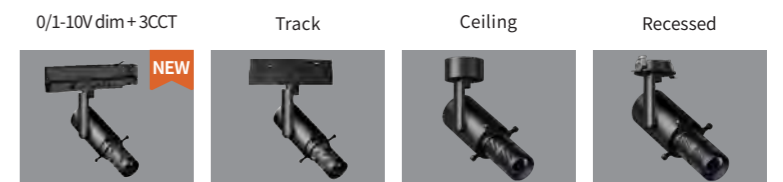



# TRACK SYSTEM

## Single-Phase / 3-Phase / Track system

Offer 1-phase/2-phase/3-phase, 3 kinds of track adapter optional  
 High compatibility with tracklight, smooth connection  
 Certificates: ENEC, CE (TUV), UL etc



**SINGLE-PHASE  
GT-208**



FOR SINGLE-PHASE TRACK SYSTEM



- **Finish:**  
White/Black/Grey
- **Mounting:**  
Track mounted (1/2/3 phase)

Feeder

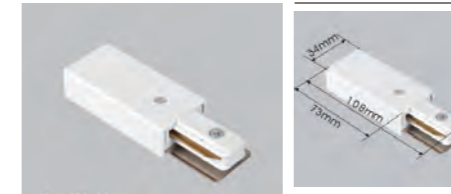

L-connector

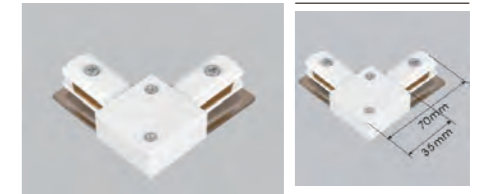

Straight connector MINI

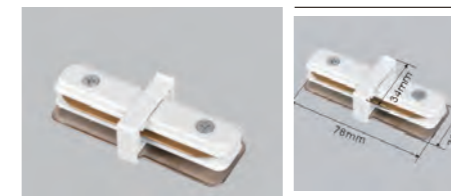

X-connector

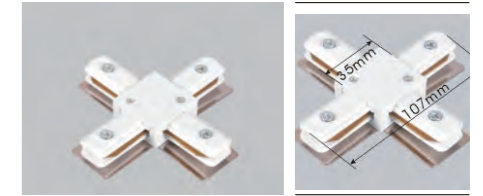

T-connector

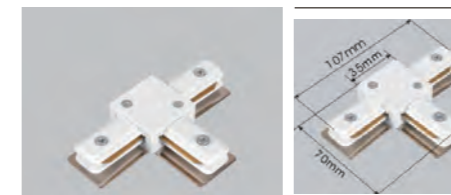

End-cap





3-PHASE  
0440S

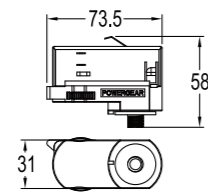

FOR 3-PHASE TRACK SYSTEM

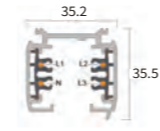

Reference Diagram for choice of connectors

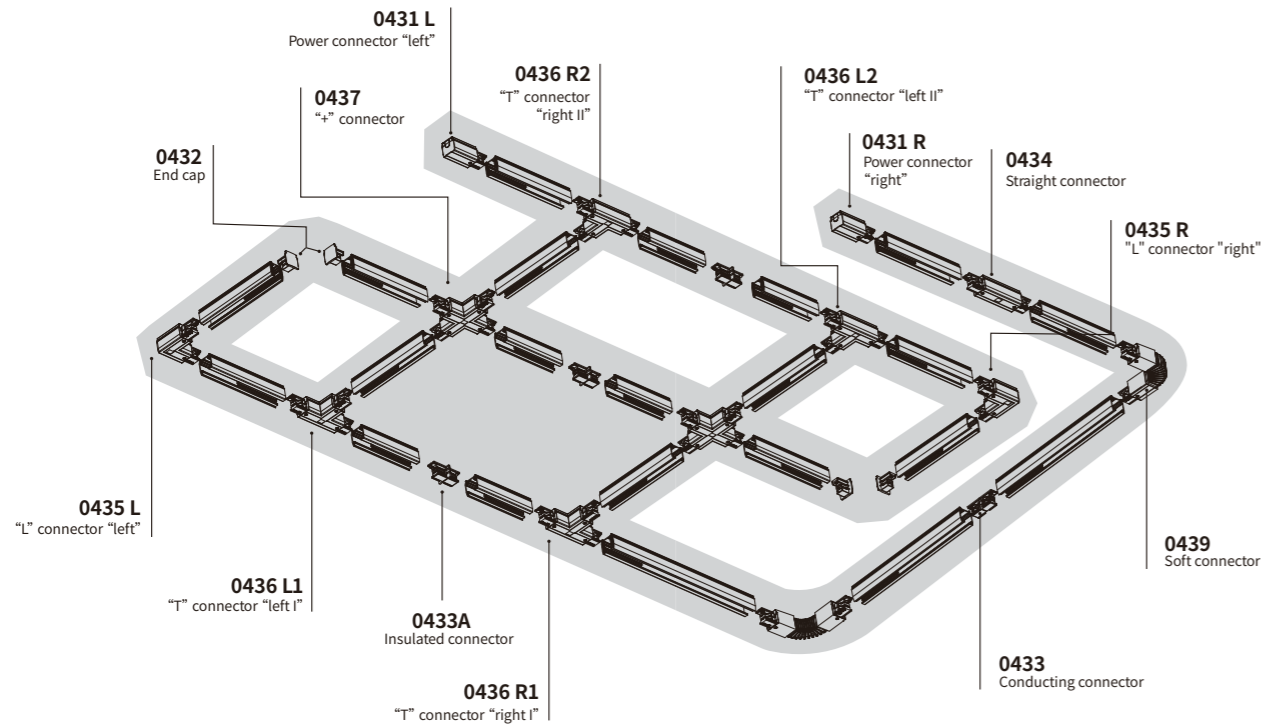

- **Finish:**  
White/Black/Grey
- **Mounting:**  
Track mounted ( 1/2/3 phase)

Power connector "left"

0431 L

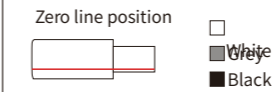
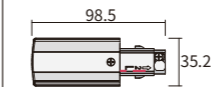

Power connector "right"

0431 R

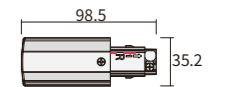

End cap

0432

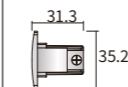

Conducting connector

0433

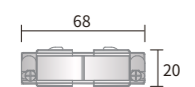

Insulated connector

0433A

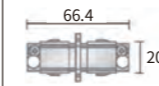

Straight connector

0434

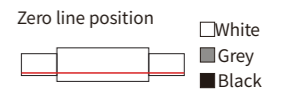
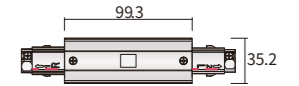

"L" connector "left"

0435 L

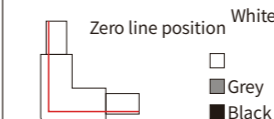
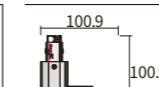

"L" connector "right"

0435 R

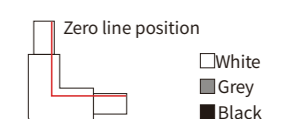
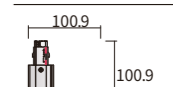

"T" connector "left I"

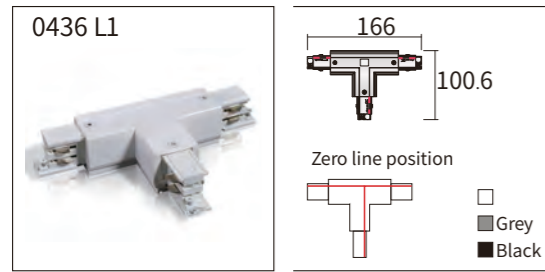

"T" connector "left II"

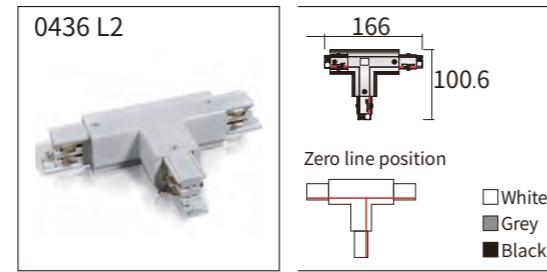

"T" connector "right I"

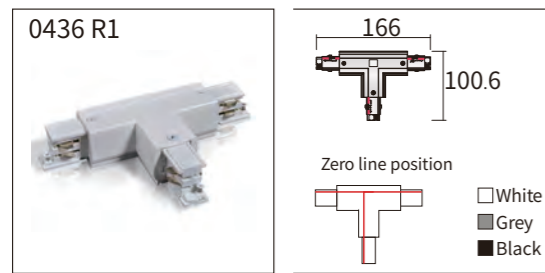

"T" connector "right II"

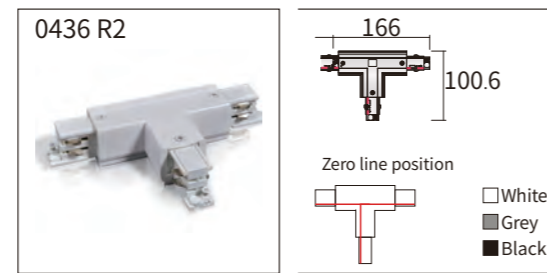

"+" connector

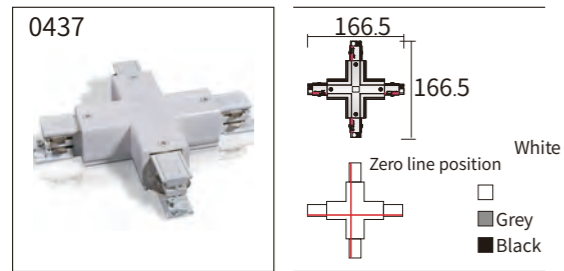

Soft connector

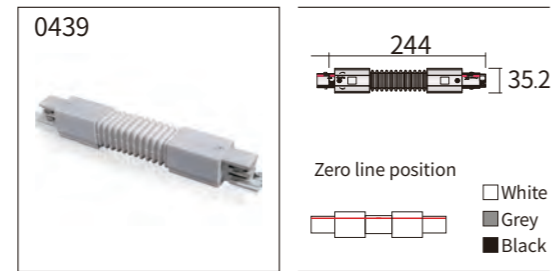

3-phase flexible "L" connector

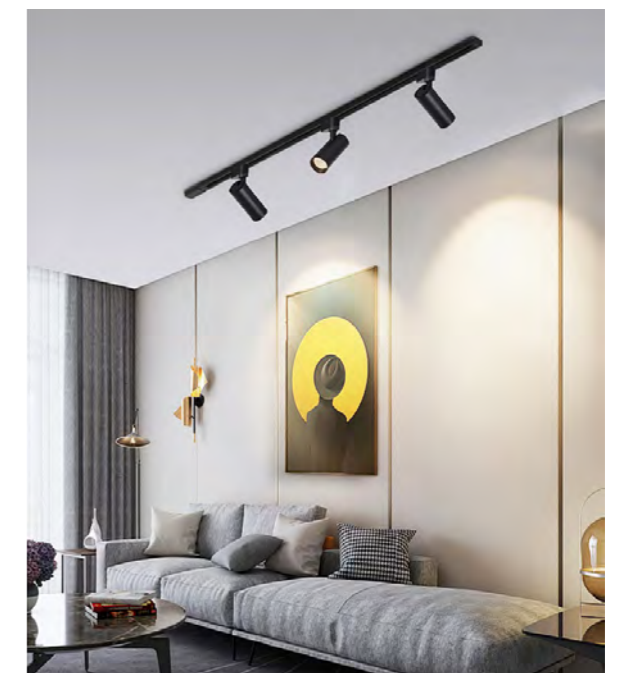
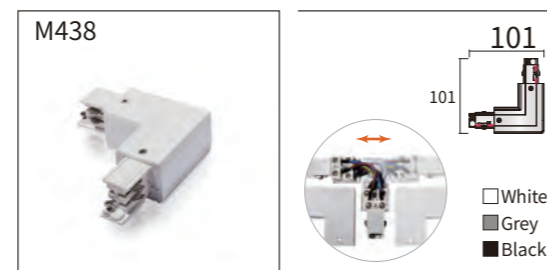
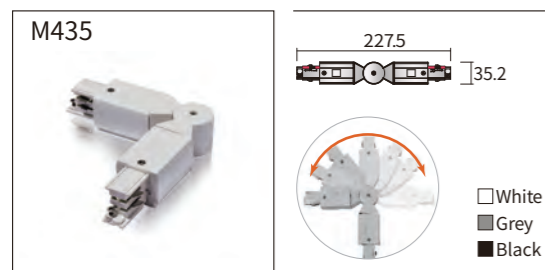

# LED Spot light



## LED SPOT LIGHT

LEGO.....003  
VELA.....003  
CIELO.....003  
SHADOW.....003  
KUDORA.....003  
MAMBA.....003

HERON.....003  
GRACE.....003  
TIDA.....003  
STAR.....003  
LUMI.....003  
NOVA.....003



# LEGO

## MODULAR ENGINE

LEGO SERIES IS TO USE REGULAR MR16/MR11 MODULAR ENGINE TO MATCH VARIOUS TYPES OF FRAMES  
 BESIDES THE MODULE IS AVAILABLE TO CHANGE THE CCT AND  
 THIS FLEXIBLE DESIGN CAN EFFECTIVELY SAVE INVENTORY



### MR16 Module Engine



| Model Code | Power | LED Current | Lumen (±5%) | Beam angle      | Input voltage         | CRI        | Dimming                  |
|------------|-------|-------------|-------------|-----------------|-----------------------|------------|--------------------------|
| LM50DL-09  | 9W    | 200mA       | 800 lm      | 15° 24° 36° 60° | AC220-240V<br>50/60Hz | ≥90<br>≥97 | Triac<br>Dali<br>0/1-10V |
| LM50DL-12  | 12W   | 300mA       | 1100 lm     |                 |                       |            |                          |

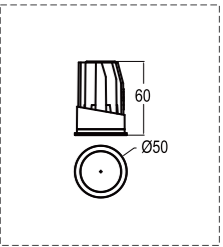

● DIP switch for CCT adjustable(on back)



| Model Code | Power | LED Current | Lumen (±5%) | Beam angle      | Input voltage         | CRI        | Dimming                  |
|------------|-------|-------------|-------------|-----------------|-----------------------|------------|--------------------------|
| LM50DL-15  | 15W   | 350mA       | 1500 lm     | 15° 24° 36° 60° | AC220-240V<br>50/60Hz | ≥90<br>≥97 | Triac<br>Dali<br>0/1-10V |
| LM50DL-18  | 18W   | 450mA       | 1700 lm     |                 |                       |            |                          |

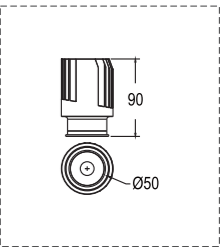

● DIP switch for CCT adjustable(on back)

### MR11 Module Engine



| Model Code | Power | LED Current | Lumen (±5%) | Beam angle      | Input voltage         | CRI        | Dimming                  |
|------------|-------|-------------|-------------|-----------------|-----------------------|------------|--------------------------|
| LM35DL-05  | 5W    | 120mA       | 450 lm      | 15° 24° 36° 60° | AC220-240V<br>50/60Hz | ≥90<br>≥97 | Triac<br>Dali<br>0/1-10V |
| LM35DL-07  | 7W    | 150mA       | 650 lm      |                 |                       |            |                          |

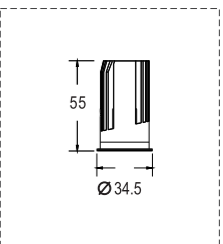

- CCT: 2700K/3000K/3500K/4000K/5700K
- Finish: White/Black
- Light source: COB LED Luminus/CREE/Bridgelux



### MR16 Module Engine

One module , multiple fits

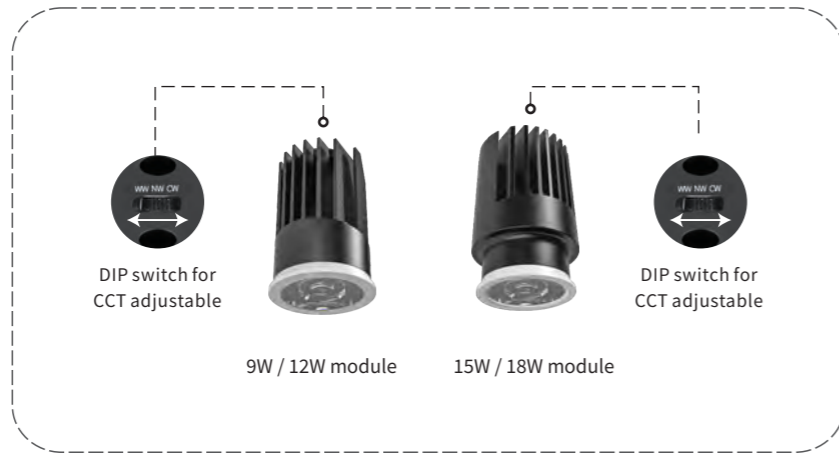

### MR11 Module Engine

One module , multiple fits

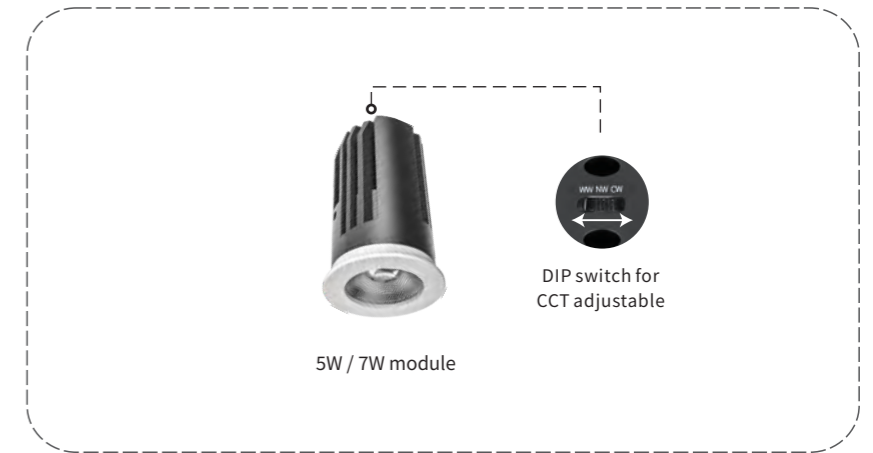

MR16 Module Engine

Interchangeable cover

LM50DL-09  
LM50DL-12



● DIP switch for CCT adjustable(on back)

LM50DL-15  
LM50DL-18



● DIP switch for CCT adjustable(on back)

|   |  |  |  |
|---|--|--|--|
| <p><b>MR16-16001</b></p> <p>Size:Ø85x22mm<br/>Cut out: Ø75mm</p>  | <p><b>MR16-16002</b></p> <p>Size:Ø110x22mm<br/>Cut out: Ø90-95mm</p>   | <p><b>MR16-16003</b></p> <p>Size:Ø85x50mm<br/>Cut out: Ø75mm</p> | <p><b>MR16-16004</b></p> <p>Size:85x85x50mm<br/>Cut out: 75x75mm</p> |
| <p><b>MR16-16005</b></p> <p>Size:Ø100x50mm<br/>Cut out: Ø90mm</p> | <p><b>MR16-16006</b></p> <p>Size:100x100x50mm<br/>Cut out: 90x90mm</p> | <p><b>MR16-SLF70</b></p> <p>Size:Ø80x25mm<br/>Cut out: Ø70mm</p> | <p><b>MR16-75ARC</b></p> <p>Size:Ø83x70mm<br/>Cut out: Ø75mm</p>     |
| <p><b>MR16-SLT70</b></p> <p>Size:Ø82x37mm<br/>Cut out: Ø70mm</p>  | <p><b>MR16-SLT90</b></p> <p>Size:Ø102x37mm<br/>Cut out: Ø90mm</p>      | <p><b>MR16-1075R</b></p> <p>Size:Ø86x45mm<br/>Cut out: Ø75mm</p> | <p><b>MR16-1075S</b></p> <p>Size:85x85x45mm<br/>Cut out: 75x75mm</p> |
| <p><b>MR16-70R</b></p> <p>Size:Ø79x47.5mm<br/>Cut out: Ø70mm</p>  | <p><b>MR16-70S</b></p> <p>Size:79x79x49mm<br/>Cut out: 70x70mm</p>     | <p><b>MR16-90R</b></p> <p>Size:Ø99x51mm<br/>Cut out: Ø90mm</p>   | <p><b>MR16-90S</b></p> <p>Size:99x99x51mm<br/>Cut out: 90x90mm</p>   |

Optional : Honey comb

MR16 Module Engine

Interchangeable cover

LM50DL-09  
LM50DL-12



● DIP switch for CCT adjustable(on back)

LM50DL-15  
LM50DL-18



● DIP switch for CCT adjustable(on back)

|  |  |  |   |
|--|--|--|---|
| <p><b>MR16-75R</b></p> <p>Size:Ø85x57mm<br/>Cut out: Ø75mm</p>               | <p><b>MR16-75RT</b></p> <p>Size:Ø95x56mm<br/>Cut out: Ø75mm</p>              | <p><b>MR16-75S</b></p> <p>Size:83x83x56mm<br/>Cut out: 75x75mm</p>       | <p><b>MR16-75ST</b></p> <p>Size:98x98x56mm<br/>Cut out: 75x75mm</p> |
| <p><b>MR16-75S2</b></p> <p>Size:158x86x56mm<br/>Cut out: 150x75mm</p>        | <p><b>MR16-75ST2</b></p> <p>Size:204.5x72x56mm<br/>Cut out: 150x75mm</p>     | <p><b>MR16-75WW</b></p> <p>Size:Ø85x52mm<br/>Cut out: Ø75mm</p>          |   |
| <p><b>MR16-100R</b></p> <p>Size:Ø111x42mm<br/>Cut out: Ø100mm</p>            | <p><b>MR16-100S</b></p> <p>Size:111x111x42mm<br/>Cut out: 100x100mm</p>      | <p><b>MR16-100S2</b></p> <p>Size:205x111x42mm<br/>Cut out: 192x100mm</p> |   |
| <p><b>MR16-16027</b></p> <p>Size:L194xØ104xH62mm<br/>Cut out: L182xØ94mm</p> | <p><b>MR16-16028</b></p> <p>Size:L180xØ146xH62mm<br/>Cut out: L182xØ92mm</p> |  |   |

Colour: Sand gold Black White Silver Chrome black

Optional : Honey comb

MR11 Module Engine

LM35DL-05  
LM35DL-07



Interchangeable cover

MR11-R40T



Size: Ø41x25.2mm  
Cut out: Ø35mm

MR11-C40



Size: 41x20mm  
Cut out: Ø35mm

MR11-T40



Size: 41x20mm  
Cut out: Ø35mm

MR11-R50



Size: Ø50x108mm  
Cut out: Ø45mm

MR11-R60



Size: Ø60x28.5mm  
Cut out: Ø50mm

MR11-F1



Size: 65x65x28.5mm  
Cut out: Ø55mm

MR11-F2



Size: 122x65x28.5mm  
Cut out: 115x55mm

MR11-F3



Size: 179x65x28.5mm  
Cut out: 170x55mm

MR11-F4



Size: 236x65x28.5mm  
Cut out: 225x55mm

Colour:



Optional:

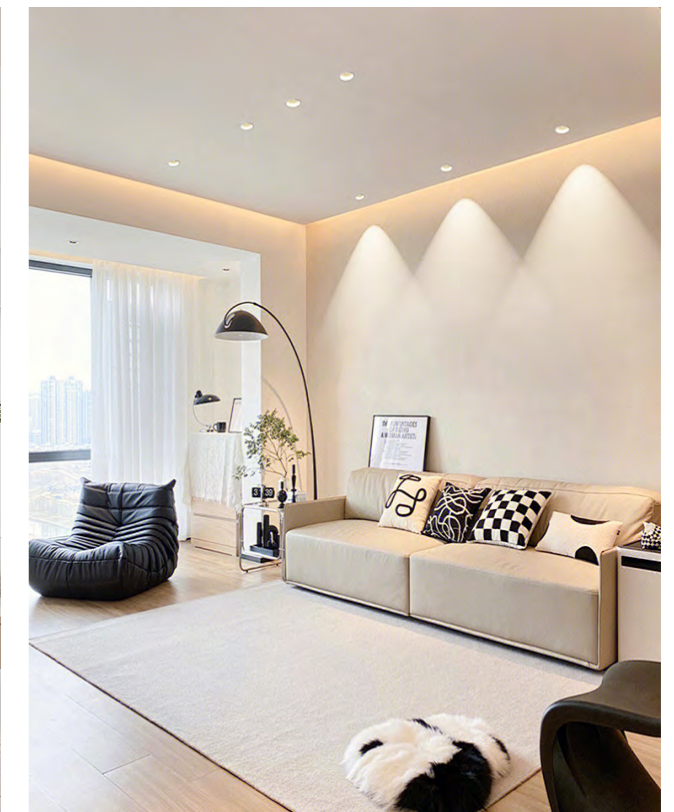
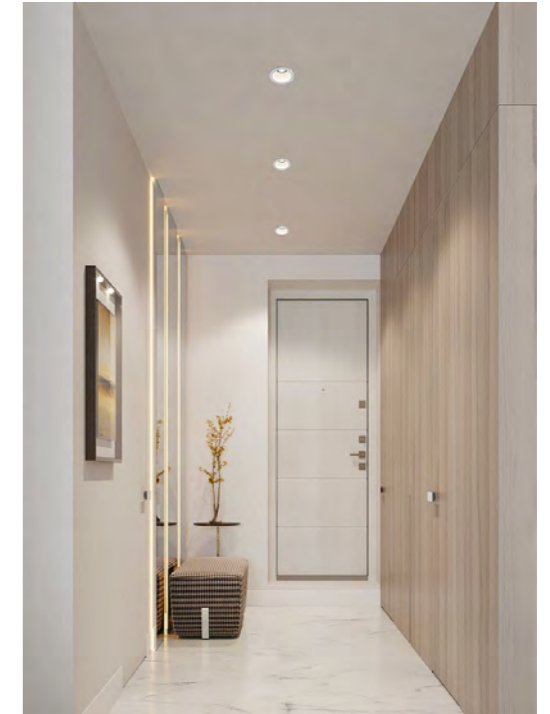
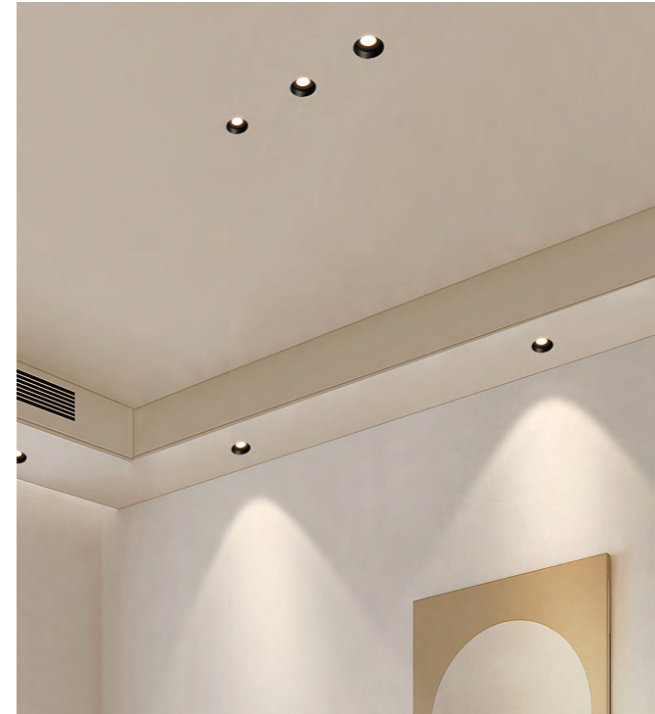



**SPLIT STRUCTURE**

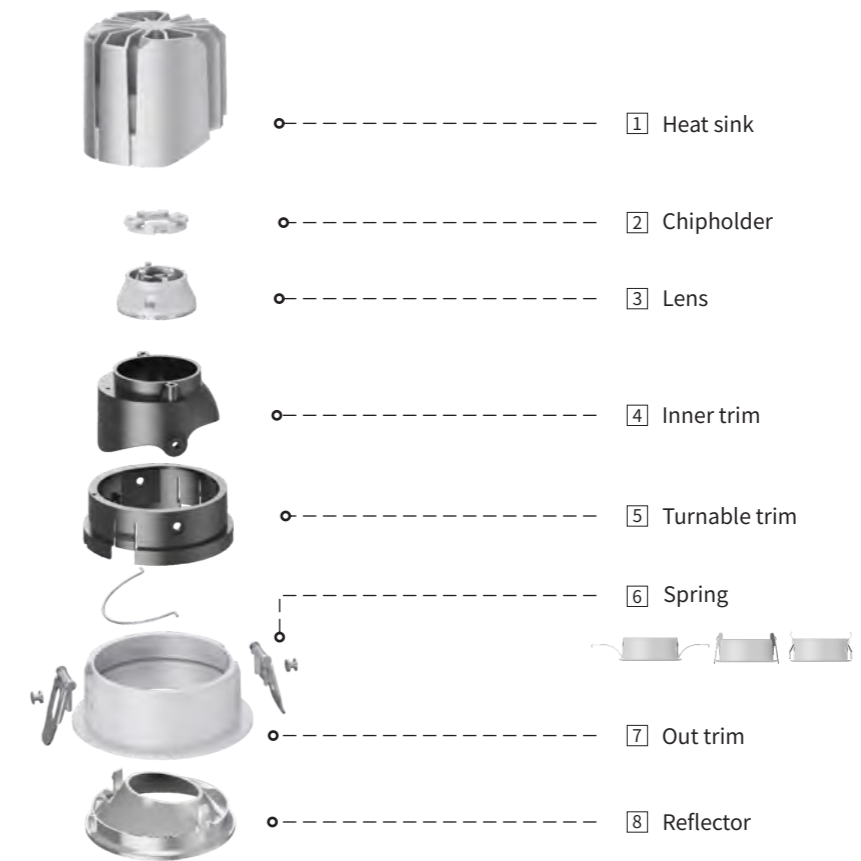

**Available in 6 colors**

Suitable for different decoration environments  
 The reflector is precisely designed with electroplating (anti UV)  
 and nano paint technology,  
 which is suitable for different soft decoration environments



### Hook design, convenient for disassembly

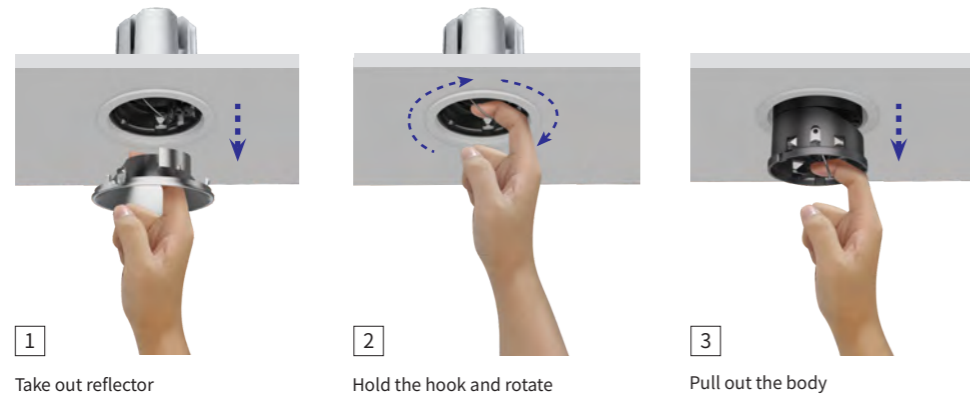

### Adjustable Angle



### Ultra-slim trim design

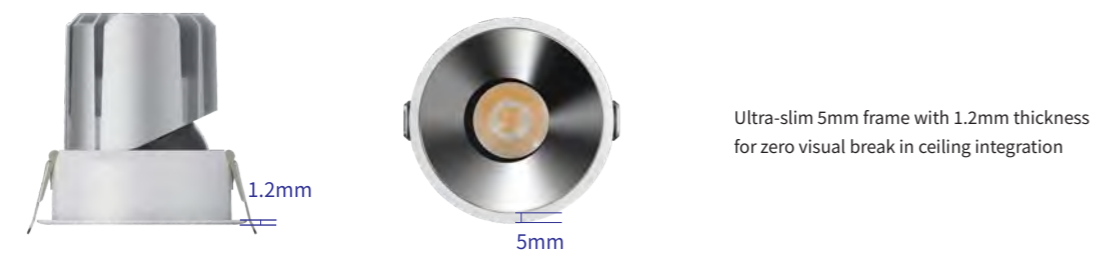

### MULTIPLE Combinations

Cut out:  $\Phi 55/\Phi 75/\Phi 95$

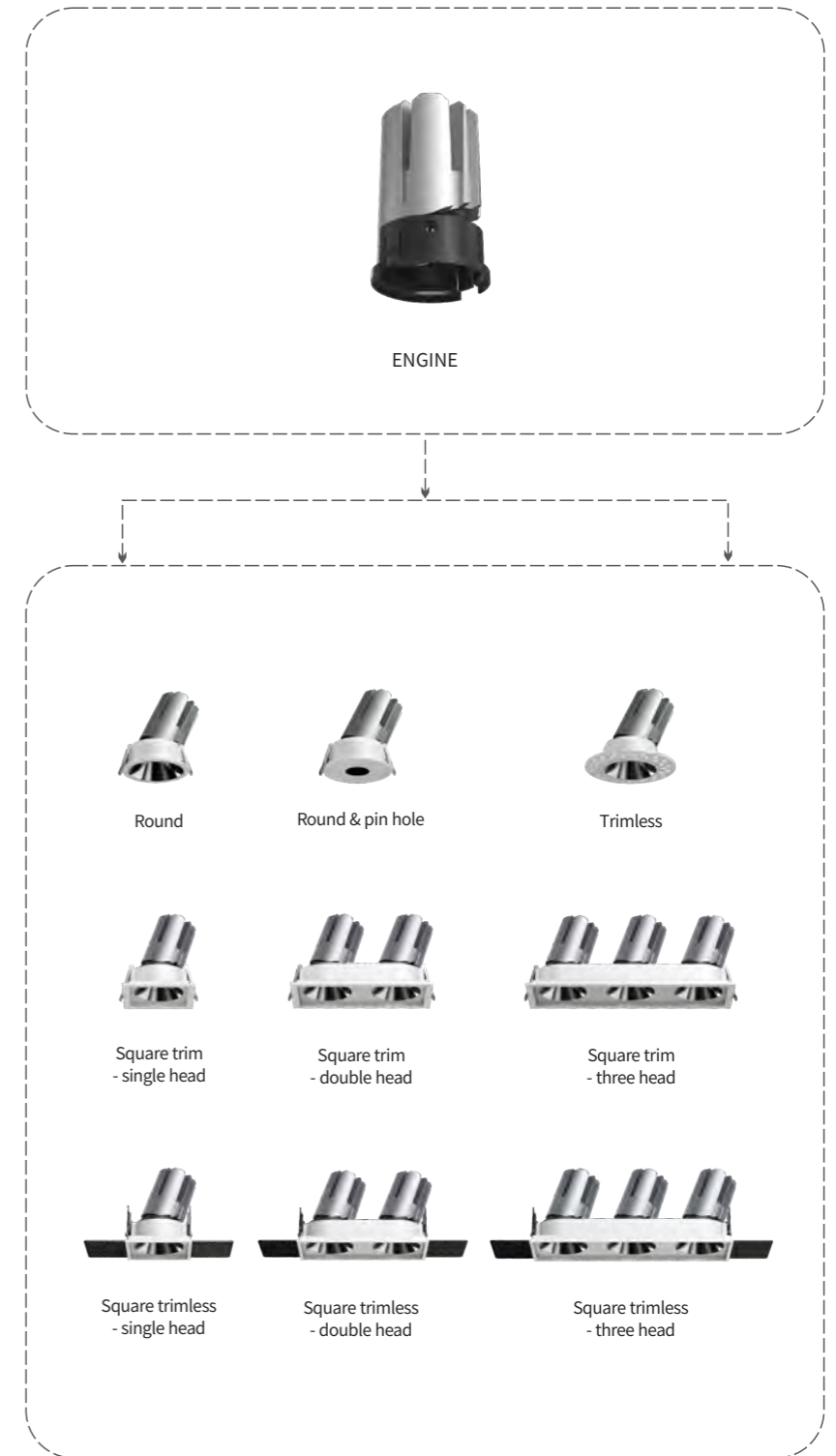



| Model Code | Power | LED Current | Lumen (±5%) | Beam angle      | Input voltage         | CRI        | Dimming                  |
|------------|-------|-------------|-------------|-----------------|-----------------------|------------|--------------------------|
| SL90R55    | 9W    | 200mA       | 750 lm      | 15° 24° 36° 50° | AC220-240V<br>50/60Hz | ≥90<br>≥97 | Triac<br>Dali<br>0/1-10V |

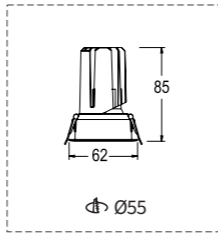

| Model Code | Power | LED Current | Lumen (±5%) | Beam angle      | Input voltage         | CRI        | Dimming                  |
|------------|-------|-------------|-------------|-----------------|-----------------------|------------|--------------------------|
| SL90S55    | 9W    | 200mA       | 750 lm      | 15° 24° 36° 50° | AC220-240V<br>50/60Hz | ≥90<br>≥97 | Triac<br>Dali<br>0/1-10V |

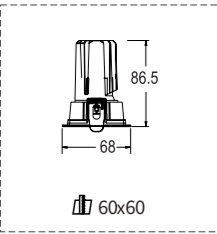

| Model Code | Power | LED Current | Lumen (±5%) | Beam angle      | Input voltage         | CRI        | Dimming                  |
|------------|-------|-------------|-------------|-----------------|-----------------------|------------|--------------------------|
| SL90R55P   | 9W    | 200mA       | 550 lm      | 15° 24° 36° 50° | AC220-240V<br>50/60Hz | ≥90<br>≥97 | Triac<br>Dali<br>0/1-10V |

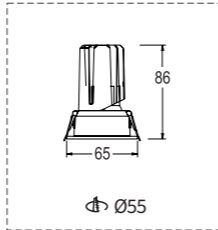

| Model Code | Power | LED Current | Lumen (±5%) | Beam angle      | Input voltage         | CRI        | Dimming                  |
|------------|-------|-------------|-------------|-----------------|-----------------------|------------|--------------------------|
| SL90S55-2  | 2x9W  | 200mA       | 1500 lm     | 15° 24° 36° 50° | AC220-240V<br>50/60Hz | ≥90<br>≥97 | Triac<br>Dali<br>0/1-10V |

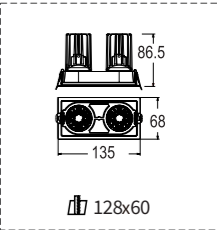

| Model Code | Power | LED Current | Lumen (±5%) | Beam angle      | Input voltage         | CRI        | Dimming                  |
|------------|-------|-------------|-------------|-----------------|-----------------------|------------|--------------------------|
| SL90RT55   | 9W    | 200mA       | 750 lm      | 15° 24° 36° 50° | AC220-240V<br>50/60Hz | ≥90<br>≥97 | Triac<br>Dali<br>0/1-10V |

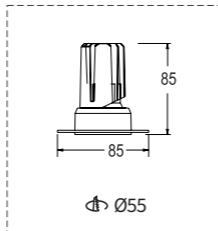

| Model Code | Power | LED Current | Lumen (±5%) | Beam angle      | Input voltage         | CRI        | Dimming                  |
|------------|-------|-------------|-------------|-----------------|-----------------------|------------|--------------------------|
| SL90S55-3  | 3x9W  | 200mA       | 2250 lm     | 15° 24° 36° 50° | AC220-240V<br>50/60Hz | ≥90<br>≥97 | Triac<br>Dali<br>0/1-10V |

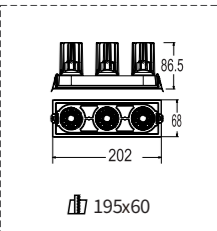

● Swivel angle:



- CCT: 2700K/3000K/3500K/4000K/5700K
- Finish: White/Black/Grey
- Light source: COB LED  
Luminus/CREE/Bridgelux

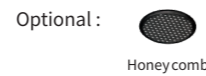

● Swivel angle:



- CCT: 2700K/3000K/3500K/4000K/5700K
- Finish: White/Black/Grey
- Light source: COB LED  
Luminus/CREE/Bridgelux

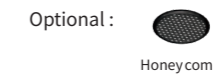

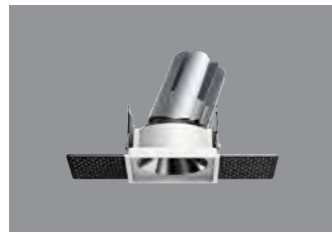

| Model Code | Power | LED Current | Lumen (±5%) | Beam angle      | Input voltage         | CRI        | Dimming                  |
|------------|-------|-------------|-------------|-----------------|-----------------------|------------|--------------------------|
| SL90ST55   | 9W    | 200mA       | 750 lm      | 15° 24° 36° 50° | AC220-240V<br>50/60Hz | ≥90<br>≥97 | Triac<br>Dali<br>0/1-10V |

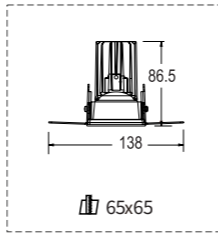

| Model Code | Power | LED Current | Lumen (±5%) | Beam angle          | Input voltage         | CRI        | Dimming                  |
|------------|-------|-------------|-------------|---------------------|-----------------------|------------|--------------------------|
| SL90R75    | 13W   | 300mA       | 1100 lm     | 10° 15° 24° 36° 50° | AC220-240V<br>50/60Hz | ≥90<br>≥97 | Triac<br>Dali<br>0/1-10V |

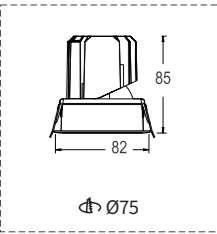

| Model Code | Power | LED Current | Lumen (±5%) | Beam angle      | Input voltage         | CRI        | Dimming                  |
|------------|-------|-------------|-------------|-----------------|-----------------------|------------|--------------------------|
| SL90ST55-2 | 2x9W  | 200mA       | 1500 lm     | 15° 24° 36° 50° | AC220-240V<br>50/60Hz | ≥90<br>≥97 | Triac<br>Dali<br>0/1-10V |

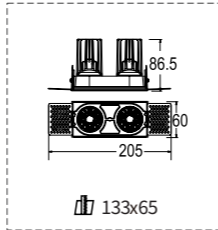

| Model Code | Power | LED Current | Lumen (±5%) | Beam angle          | Input voltage         | CRI        | Dimming                  |
|------------|-------|-------------|-------------|---------------------|-----------------------|------------|--------------------------|
| SL90R75P   | 13W   | 300mA       | 950 lm      | 10° 15° 24° 36° 50° | AC220-240V<br>50/60Hz | ≥90<br>≥97 | Triac<br>Dali<br>0/1-10V |

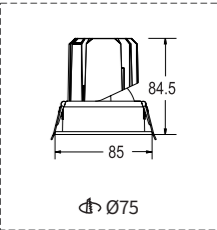

| Model Code | Power | LED Current | Lumen (±5%) | Beam angle      | Input voltage         | CRI        | Dimming                  |
|------------|-------|-------------|-------------|-----------------|-----------------------|------------|--------------------------|
| SL90ST55-3 | 3x9W  | 200mA       | 2250 lm     | 15° 24° 36° 50° | AC220-240V<br>50/60Hz | ≥90<br>≥97 | Triac<br>Dali<br>0/1-10V |

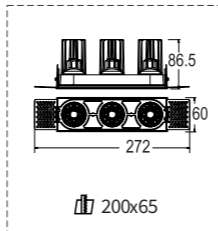

| Model Code | Power | LED Current | Lumen (±5%) | Beam angle          | Input voltage         | CRI        | Dimming                  |
|------------|-------|-------------|-------------|---------------------|-----------------------|------------|--------------------------|
| SL90RT75   | 13W   | 300mA       | 1100 lm     | 10° 15° 24° 36° 50° | AC220-240V<br>50/60Hz | ≥90<br>≥97 | Triac<br>Dali<br>0/1-10V |

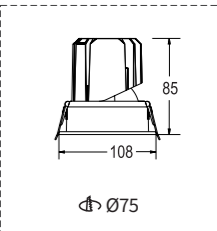

● Swivel angle:



- CCT: 2700K/3000K/3500K/4000K/5700K
- Finish: White/Black/Grey
- Light source: COB LED  
Luminus/CREE/Bridgelux

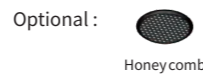

● Swivel angle:



- CCT: 2700K/3000K/3500K/4000K/5700K
- Finish: White/Black/Grey
- Light source: COB LED  
Luminus/CREE/Bridgelux

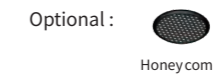

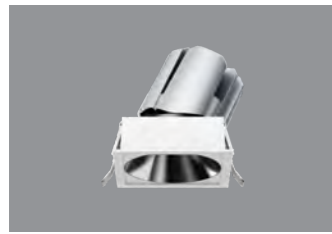

| Model Code | Power | LED Current | Lumen (±5%) | Beam angle          | Input voltage         | CRI        | Dimming                  |
|------------|-------|-------------|-------------|---------------------|-----------------------|------------|--------------------------|
| SL90S75    | 13W   | 300mA       | 1100 lm     | 10° 15° 24° 36° 50° | AC220-240V<br>50/60Hz | ≥90<br>≥97 | Triac<br>Dali<br>0/1-10V |

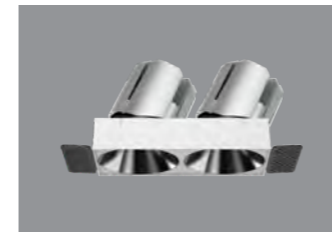
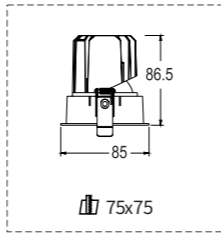

| Model Code | Power | LED Current | Lumen (±5%) | Beam angle          | Input voltage         | CRI        | Dimming                  |
|------------|-------|-------------|-------------|---------------------|-----------------------|------------|--------------------------|
| SL90ST75-2 | 2x13W | 300mA       | 2200 lm     | 10° 15° 24° 36° 50° | AC220-240V<br>50/60Hz | ≥90<br>≥97 | Triac<br>Dali<br>0/1-10V |

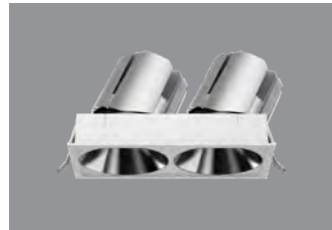
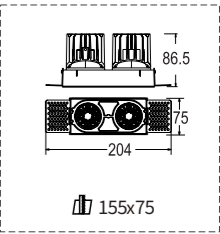

| Model Code | Power | LED Current | Lumen (±5%) | Beam angle          | Input voltage         | CRI        | Dimming                  |
|------------|-------|-------------|-------------|---------------------|-----------------------|------------|--------------------------|
| SL90S75-2  | 2x13W | 300mA       | 2200 lm     | 10° 15° 24° 36° 50° | AC220-240V<br>50/60Hz | ≥90<br>≥97 | Triac<br>Dali<br>0/1-10V |

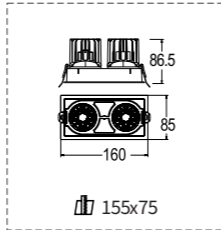

| Model Code | Power | LED Current | Lumen (±5%) | Beam angle      | Input voltage         | CRI        | Dimming                  |
|------------|-------|-------------|-------------|-----------------|-----------------------|------------|--------------------------|
| SL90R95    | 25W   | 600mA       | 2500 lm     | 15° 24° 36° 50° | AC220-240V<br>50/60Hz | ≥90<br>≥97 | Triac<br>Dali<br>0/1-10V |

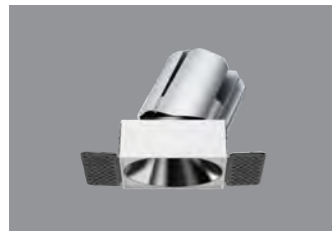
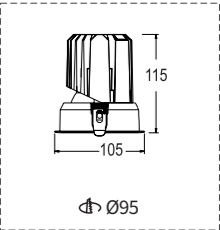

| Model Code | Power | LED Current | Lumen (±5%) | Beam angle          | Input voltage         | CRI        | Dimming                  |
|------------|-------|-------------|-------------|---------------------|-----------------------|------------|--------------------------|
| SL90ST75   | 13W   | 300mA       | 1100 lm     | 10° 15° 24° 36° 50° | AC220-240V<br>50/60Hz | ≥90<br>≥97 | Triac<br>Dali<br>0/1-10V |

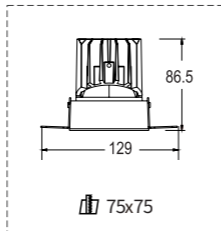

| Model Code | Power | LED Current | Lumen (±5%) | Beam angle      | Input voltage         | CRI        | Dimming                  |
|------------|-------|-------------|-------------|-----------------|-----------------------|------------|--------------------------|
| SL90RT95   | 25W   | 600mA       | 2500 lm     | 15° 24° 36° 50° | AC220-240V<br>50/60Hz | ≥90<br>≥97 | Triac<br>Dali<br>0/1-10V |

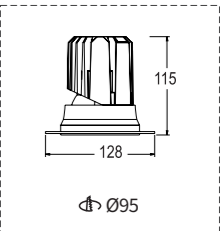

● Swivel angle:



- CCT: 2700K/3000K/3500K/4000K/5700K
- Finish: White/Black/Grey
- Light source: COB LED  
Luminus/CREE/Bridgelux

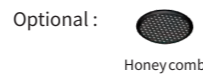

● Swivel angle:



- CCT: 2700K/3000K/3500K/4000K/5700K
- Finish: White/Black/Grey
- Light source: COB LED  
Luminus/CREE/Bridgelux

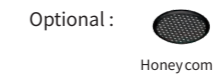



# CIELO

## LED SPOT LIGHT

CIELO series is specially designed for high-end hotel projects ,die-casting aluminium heatsink with great heat dissipation  
 Various of reflector colors is most helpful to reduce glare and modular design effectively reduce the inventory  
 and different cuout size to adapt to different applications.



**SPLIT STRUCTURE**

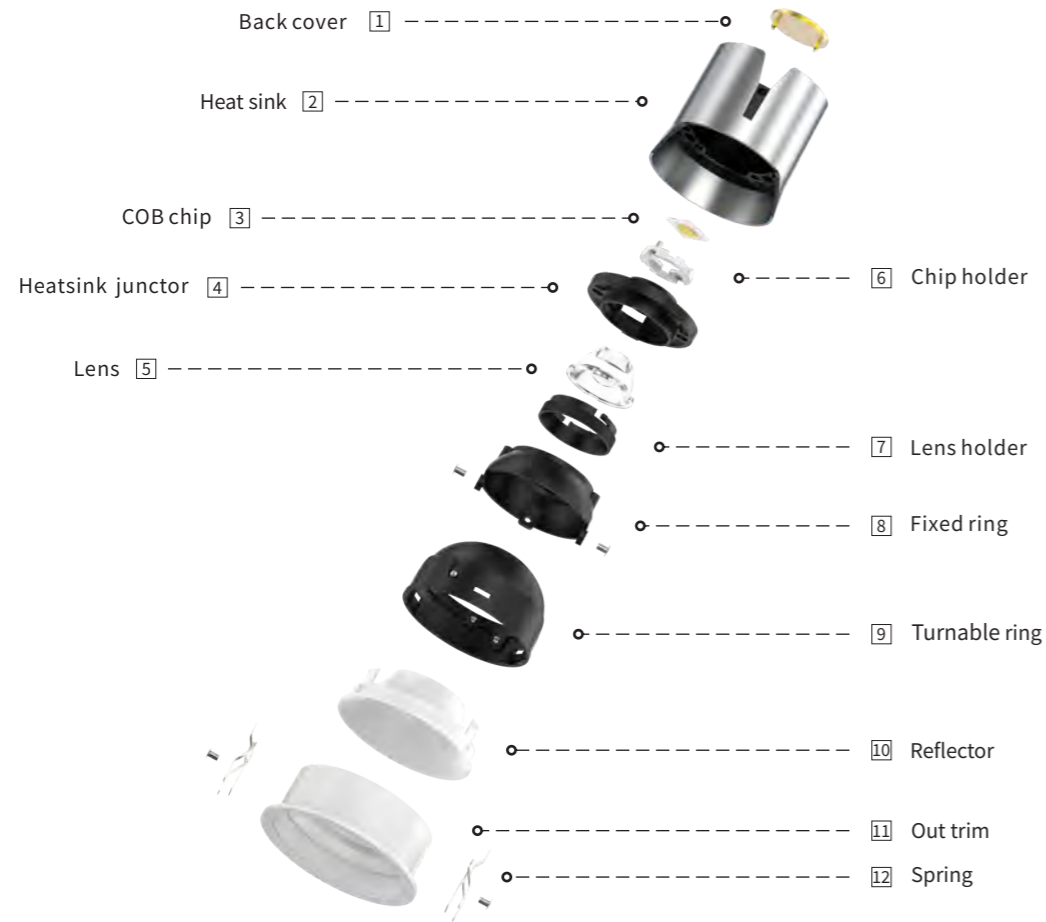

**Available in 3 colors**

Suitable for different decoration environments  
The reflector is precisely designed with electroplating (anti UV) and nano paint technology, which is suitable for different soft decoration environments



**Hook design, convenient for disassembly**

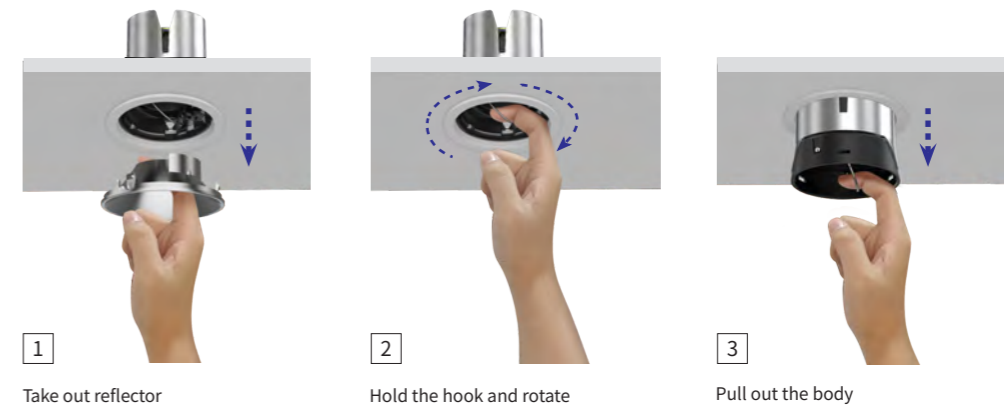

**Interchangeable inner ring design**



**Adjustable Angle**

Tilt 30° vertically, rotate 355° horizontally

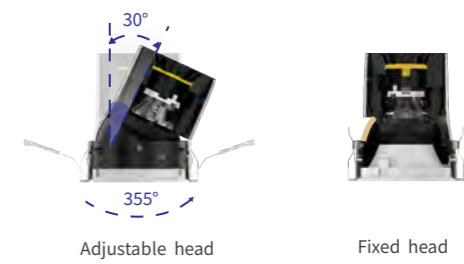

**Ultra-slim trim design**



Ultra-slim 5mm frame with 1.2mm thickness for zero visual break in ceiling integration



| Model Code | Power | LED Current | Lumen (±5%) | Beam angle  | Input voltage         | CRI        | Dimming                  |
|------------|-------|-------------|-------------|-------------|-----------------------|------------|--------------------------|
| SL05R55    | 7W    | 180mA       | 600 lm      | 15° 24° 36° | AC220-240V<br>50/60Hz | ≥90<br>≥97 | Triac<br>Dali<br>0/1-10V |

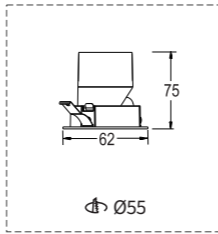

| Model Code | Power | LED Current | Lumen (±5%) | Beam angle  | Input voltage         | CRI        | Dimming                  |
|------------|-------|-------------|-------------|-------------|-----------------------|------------|--------------------------|
| SL05RT55   | 7W    | 180mA       | 600 lm      | 15° 24° 36° | AC220-240V<br>50/60Hz | ≥90<br>≥97 | Triac<br>Dali<br>0/1-10V |

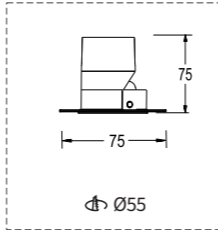

| Model Code | Power | LED Current | Lumen (±5%) | Beam angle  | Input voltage         | CRI        | Dimming                  |
|------------|-------|-------------|-------------|-------------|-----------------------|------------|--------------------------|
| SL05R55Z   | 7W    | 180mA       | 600 lm      | 15° 24° 36° | AC220-240V<br>50/60Hz | ≥90<br>≥97 | Triac<br>Dali<br>0/1-10V |

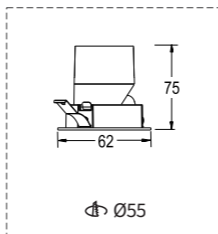

- **Swivel angle:**
- **CCT:**  
2700K/3000K/3500K/4000K/5700K
- **Finish:**  
White/Black/Grey
- **Light source:**  
COB LED  
Luminus/CREE/Bridgelux



| Model Code | Power | LED Current | Lumen (±5%) | Beam angle  | Input voltage         | CRI        | Dimming                  |
|------------|-------|-------------|-------------|-------------|-----------------------|------------|--------------------------|
| SL05S55    | 7W    | 180mA       | 600 lm      | 15° 24° 36° | AC220-240V<br>50/60Hz | ≥90<br>≥97 | Triac<br>Dali<br>0/1-10V |

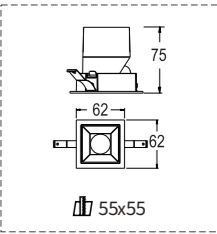

| Model Code | Power | LED Current | Lumen (±5%) | Beam angle  | Input voltage         | CRI        | Dimming                  |
|------------|-------|-------------|-------------|-------------|-----------------------|------------|--------------------------|
| SL05ST55   | 7W    | 180mA       | 600 lm      | 15° 24° 36° | AC220-240V<br>50/60Hz | ≥90<br>≥97 | Triac<br>Dali<br>0/1-10V |

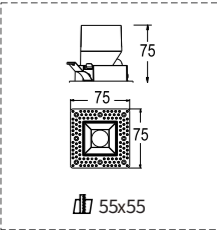

| Model Code | Power | LED Current | Lumen (±5%) | Beam angle  | Input voltage         | CRI        | Dimming                  |
|------------|-------|-------------|-------------|-------------|-----------------------|------------|--------------------------|
| SL05S55-2  | 2x7W  | 180mA       | 1200 lm     | 15° 24° 36° | AC220-240V<br>50/60Hz | ≥90<br>≥97 | Triac<br>Dali<br>0/1-10V |

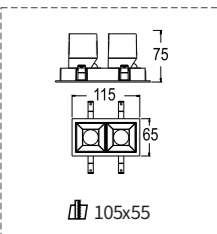

| Model Code | Power | LED Current | Lumen (±5%) | Beam angle  | Input voltage         | CRI        | Dimming                  |
|------------|-------|-------------|-------------|-------------|-----------------------|------------|--------------------------|
| SL05ST55-2 | 2x7W  | 180mA       | 1200 lm     | 15° 24° 36° | AC220-240V<br>50/60Hz | ≥90<br>≥97 | Triac<br>Dali<br>0/1-10V |

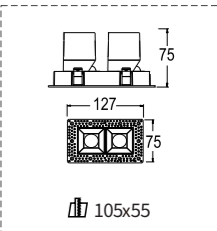

- **Swivel angle:**
- **CCT:**  
2700K/3000K/3500K/4000K/5700K
- **Finish:**  
White/Black/Grey
- **Light source:**  
COB LED  
Luminus/CREE/Bridgelux

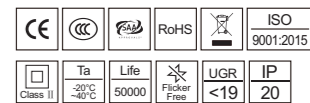



| Model Code | Power | LED Current | Lumen (±5%) | Beam angle  | Input voltage         | CRI        | Dimming                  |
|------------|-------|-------------|-------------|-------------|-----------------------|------------|--------------------------|
| SL05R75    | 12W   | 300mA       | 950 lm      | 15° 24° 36° | AC220-240V<br>50/60Hz | ≥90<br>≥97 | Triac<br>Dali<br>0/1-10V |

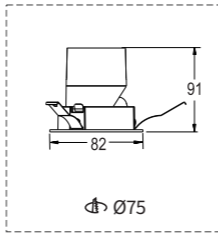

| Model Code | Power | LED Current | Lumen (±5%) | Beam angle  | Input voltage         | CRI        | Dimming                  |
|------------|-------|-------------|-------------|-------------|-----------------------|------------|--------------------------|
| SL05RT75   | 12W   | 300mA       | 950 lm      | 15° 24° 36° | AC220-240V<br>50/60Hz | ≥90<br>≥97 | Triac<br>Dali<br>0/1-10V |

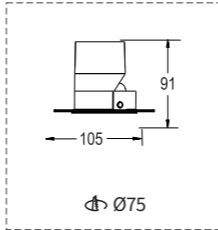

| Model Code | Power | LED Current | Lumen (±5%) | Beam angle  | Input voltage         | CRI        | Dimming                  |
|------------|-------|-------------|-------------|-------------|-----------------------|------------|--------------------------|
| SL05R75Z   | 12W   | 300mA       | 850 lm      | 15° 24° 36° | AC220-240V<br>50/60Hz | ≥90<br>≥97 | Triac<br>Dali<br>0/1-10V |

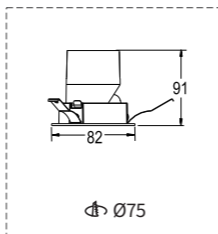

- **Swivel angle:**
- **CCT:**  
2700K/3000K/3500K/4000K/5700K
- **Finish:**  
White/Black/Grey
- **Light source:**  
COB LED  
Luminus/CREE/Bridgelux

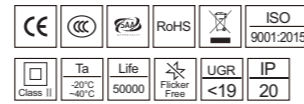

- Colour:      Optional:
- Chrome black   Matt Black   Matt White      Honey comb



| Model Code | Power | LED Current | Lumen (±5%) | Beam angle  | Input voltage         | CRI        | Dimming                  |
|------------|-------|-------------|-------------|-------------|-----------------------|------------|--------------------------|
| SL05S75    | 12W   | 300mA       | 950 lm      | 15° 24° 36° | AC220-240V<br>50/60Hz | ≥90<br>≥97 | Triac<br>Dali<br>0/1-10V |

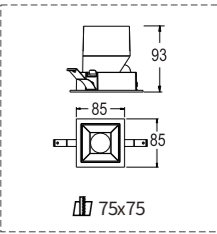

| Model Code | Power | LED Current | Lumen (±5%) | Beam angle  | Input voltage         | CRI        | Dimming                  |
|------------|-------|-------------|-------------|-------------|-----------------------|------------|--------------------------|
| SL05ST75   | 12W   | 300mA       | 950 lm      | 15° 24° 36° | AC220-240V<br>50/60Hz | ≥90<br>≥97 | Triac<br>Dali<br>0/1-10V |

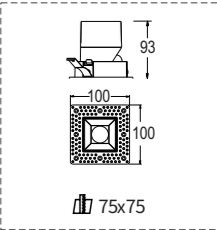

| Model Code | Power | LED Current | Lumen (±5%) | Beam angle  | Input voltage         | CRI        | Dimming                  |
|------------|-------|-------------|-------------|-------------|-----------------------|------------|--------------------------|
| SL05S75-2  | 2x12W | 300mA       | 1900 lm     | 15° 24° 36° | AC220-240V<br>50/60Hz | ≥90<br>≥97 | Triac<br>Dali<br>0/1-10V |

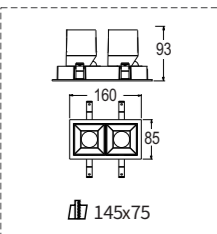

| Model Code | Power | LED Current | Lumen (±5%) | Beam angle  | Input voltage         | CRI        | Dimming                  |
|------------|-------|-------------|-------------|-------------|-----------------------|------------|--------------------------|
| SL05ST75-2 | 2x12W | 300mA       | 1900 lm     | 15° 24° 36° | AC220-240V<br>50/60Hz | ≥90<br>≥97 | Triac<br>Dali<br>0/1-10V |

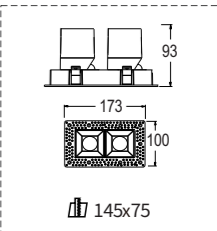

- **Swivel angle:**
- **CCT:**  
2700K/3000K/3500K/4000K/5700K
- **Finish:**  
White/Black/Grey
- **Light source:**  
COB LED  
Luminus/CREE/Bridgelux

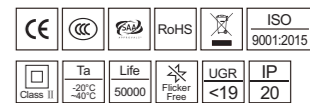

- Colour:      Optional:
- Chrome black   Matt Black   Matt White      Honey comb



Available in 3 colors

Suitable for different decoration environments  
The reflector is precisely designed with electroplating (anti UV) and nano paint technology, which is suitable for different soft decoration environments



| Model Code | Power | LED Current | Lumen (±5%) | Beam angle  | Input voltage         | CRI        | Dimming                  |
|------------|-------|-------------|-------------|-------------|-----------------------|------------|--------------------------|
| SL05R55S1  | 7W    | 180mA       | 500 lm      | 15° 24° 36° | AC220-240V<br>50/60Hz | ≥90<br>≥97 | Triac<br>Dali<br>0/1-10V |

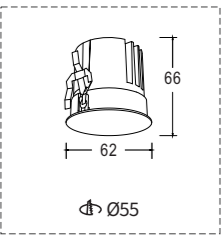

| Model Code | Power | LED Current | Lumen (±5%) | Beam angle | Input voltage         | CRI        | Dimming                  |
|------------|-------|-------------|-------------|------------|-----------------------|------------|--------------------------|
| SL05R55S2  | 7W    | 180mA       | 550 lm      | 36°        | AC220-240V<br>50/60Hz | ≥90<br>≥97 | Triac<br>Dali<br>0/1-10V |

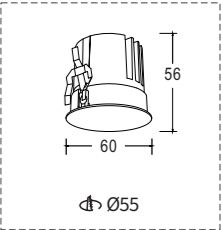

| Model Code | Power | LED Current | Lumen (±5%) | Beam angle  | Input voltage         | CRI        | Dimming                  |
|------------|-------|-------------|-------------|-------------|-----------------------|------------|--------------------------|
| SL05R55S3  | 7W    | 180mA       | 500 lm      | 15° 24° 36° | AC220-240V<br>50/60Hz | ≥90<br>≥97 | Triac<br>Dali<br>0/1-10V |

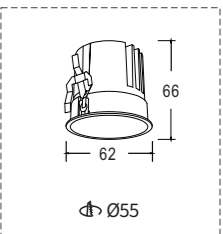

| Model Code | Power | LED Current | Lumen (±5%) | Beam angle | Input voltage         | CRI        | Dimming                  |
|------------|-------|-------------|-------------|------------|-----------------------|------------|--------------------------|
| SL05R55S4  | 7W    | 180mA       | 550 lm      | 36°        | AC220-240V<br>50/60Hz | ≥90<br>≥97 | Triac<br>Dali<br>0/1-10V |

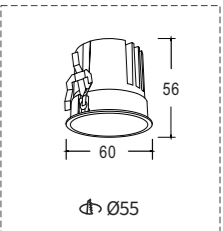

- **CCT:**  
2700K/3000K/3500K/4000K/5700K
- **Finish:**  
White/Black
- **Light source:**  
COB LED  
Luminus/CREE/Bridgelux

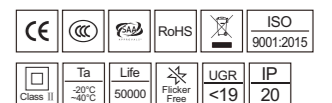



| Model Code | Power | LED Current | Lumen (±5%) | Beam angle  | Input voltage         | CRI        | Dimming                  |
|------------|-------|-------------|-------------|-------------|-----------------------|------------|--------------------------|
| SL05R75S1  | 12W   | 300mA       | 950 lm      | 15° 24° 36° | AC220-240V<br>50/60Hz | ≥90<br>≥97 | Triac<br>Dali<br>0/1-10V |

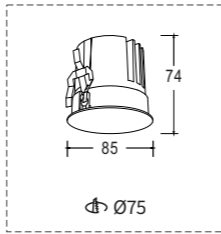

| Model Code | Power | LED Current | Lumen (±5%) | Beam angle | Input voltage         | CRI        | Dimming                  |
|------------|-------|-------------|-------------|------------|-----------------------|------------|--------------------------|
| SL05R75S2  | 12W   | 300mA       | 950 lm      | 36°        | AC220-240V<br>50/60Hz | ≥90<br>≥97 | Triac<br>Dali<br>0/1-10V |

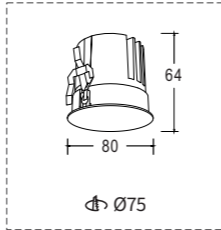

| Model Code | Power | LED Current | Lumen (±5%) | Beam angle  | Input voltage         | CRI        | Dimming                  |
|------------|-------|-------------|-------------|-------------|-----------------------|------------|--------------------------|
| SL05R75S3  | 12W   | 300mA       | 800 lm      | 15° 24° 36° | AC220-240V<br>50/60Hz | ≥90<br>≥97 | Triac<br>Dali<br>0/1-10V |

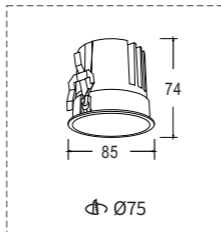

| Model Code | Power | LED Current | Lumen (±5%) | Beam angle | Input voltage         | CRI        | Dimming                  |
|------------|-------|-------------|-------------|------------|-----------------------|------------|--------------------------|
| SL05R75S4  | 12W   | 300mA       | 950 lm      | 36°        | AC220-240V<br>50/60Hz | ≥90<br>≥97 | Triac<br>Dali<br>0/1-10V |

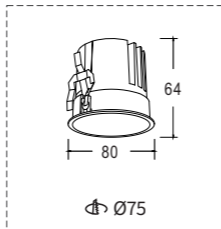

- **CCT:**  
2700K/3000K/3500K/4000K/5700K
- **Finish:**  
White/Black/Grey
- **Light source:**  
COB LED  
Luminus/CREE/Bridgelux

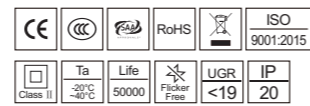

- Colour: Chrome black Matt Black Matt White
- Optional: Honey comb

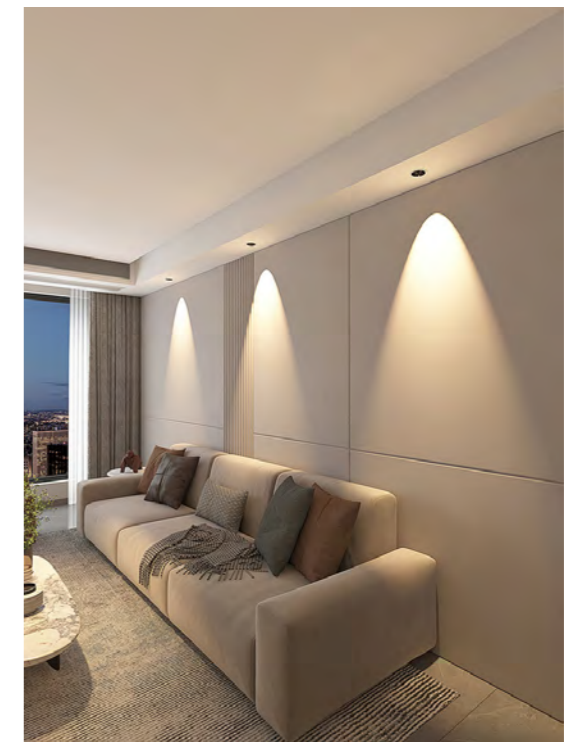
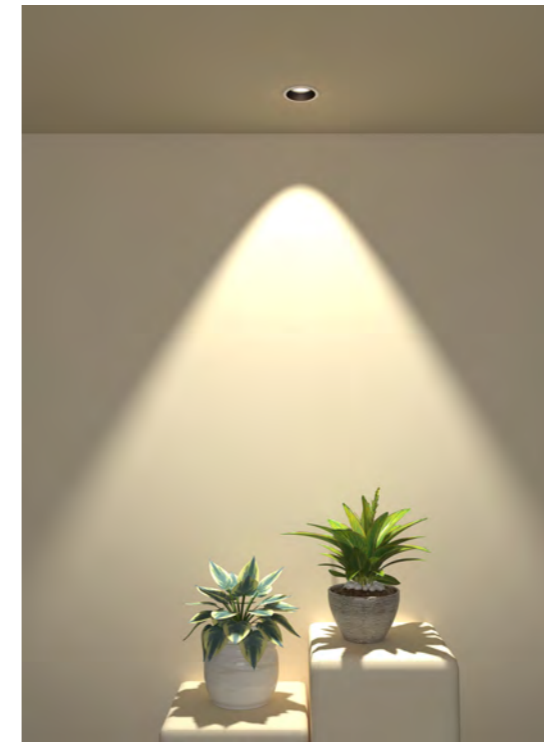
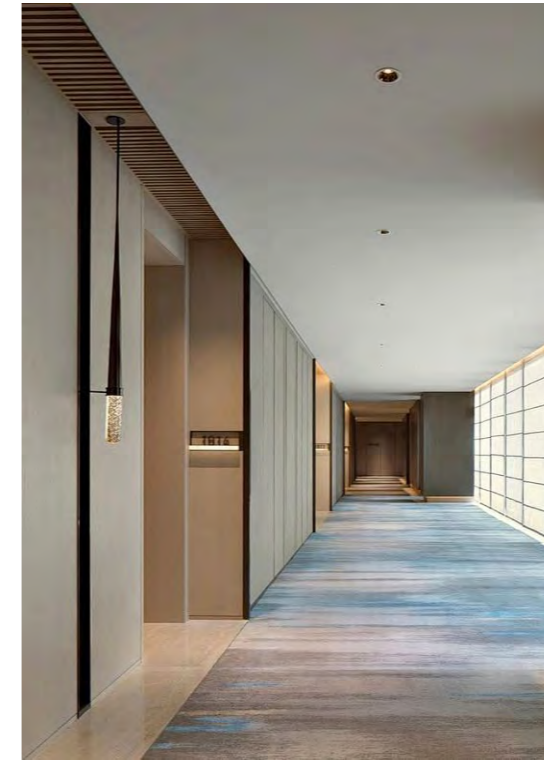



# SHADOW

## LED SPOT LIGHT

THE LAMP HAS PASSED IP65 WATERPROOF TEST AND 500H OF SALT SPRAY TEST  
 ULTRA-THIN DESIGN, FRAME NARROW TO 5MM, THICKNESS 1.2MM  
 DEEP ANTI GLARE, UGR<6, SEVEN SIZES AVAILABLE, 12 COLOURS ARE AVAILABLE AS CUSTOM OPTIONS

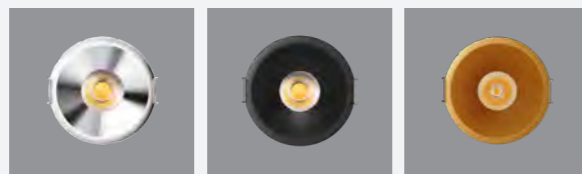

## SPLIT STRUCTURE

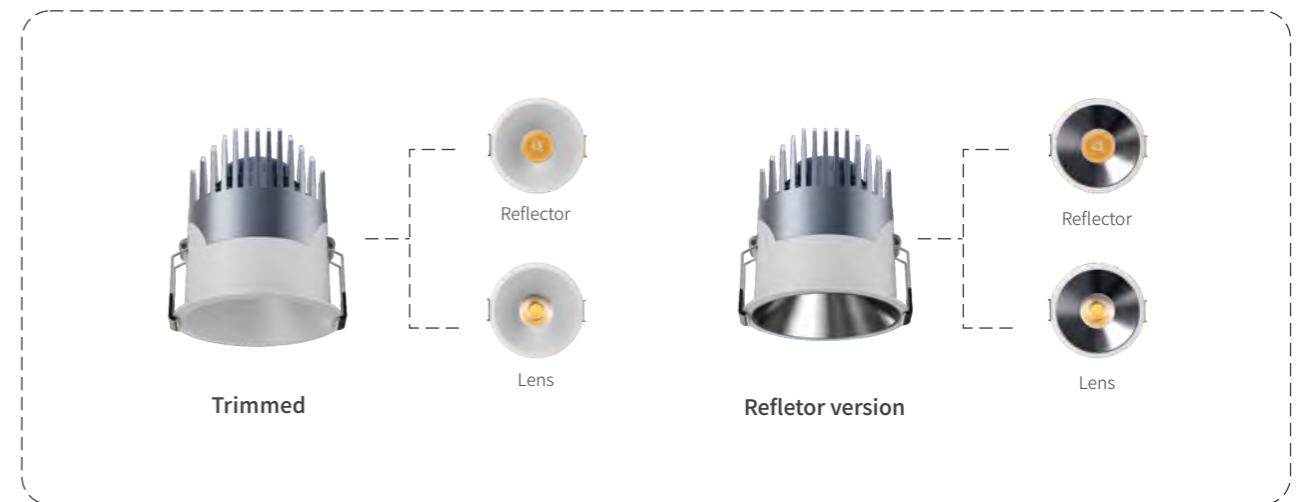
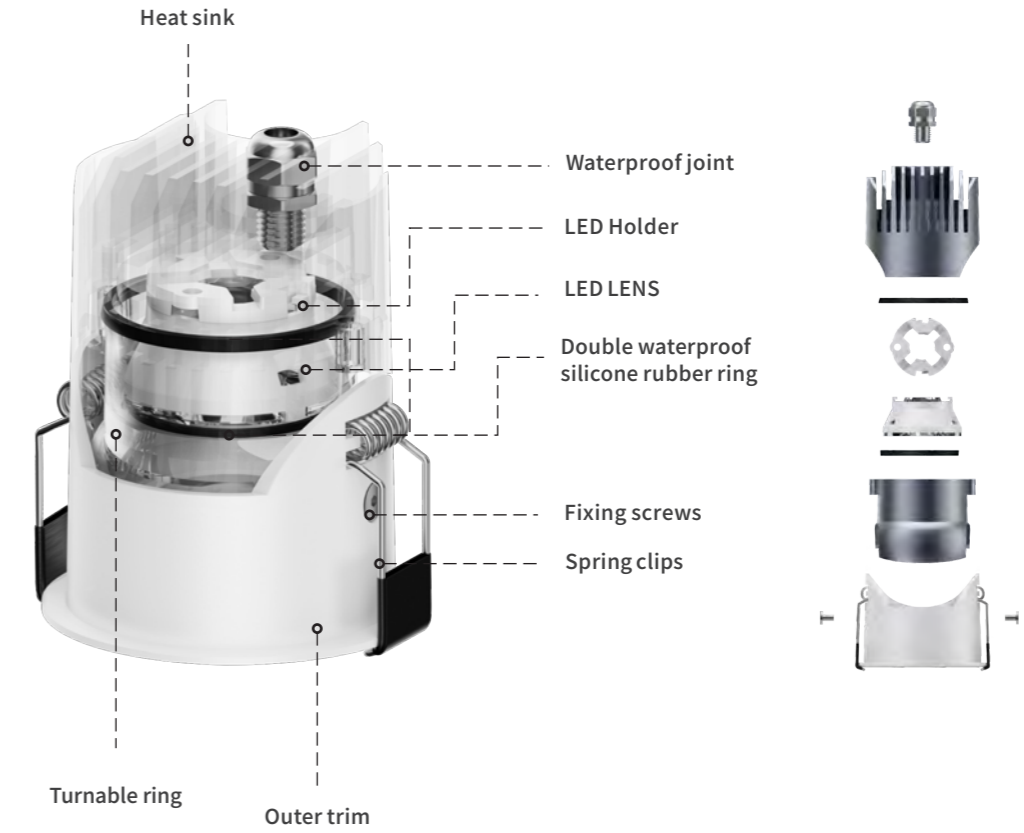

LED Spot light



| Model Code | Power | LED Current | Lumen (±5%) | Beam angle  | Input voltage         | CRI        | Dimming                  |
|------------|-------|-------------|-------------|---|-----------------------|------------|--------------------------|
| SLO7R35    | 7W    | 120mA       | 450 lm      | (Lens)<br>10°15°24°36° 50°<br>(Reflector)<br>15°24° 38° | AC220-240V<br>50/60Hz | ≥90<br>≥97 | Triac<br>Dali<br>0/1-10V |

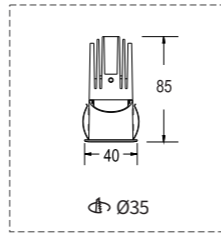

| Model Code | Power | LED Current | Lumen (±5%) | Beam angle  | Input voltage         | CRI        | Dimming                  |
|------------|-------|-------------|-------------|---|-----------------------|------------|--------------------------|
| SLO7R45    | 7W    | 120mA       | 450 lm      | (Lens)<br>10°15°24°36° 50°<br>(Reflector)<br>15°24° 38° | AC220-240V<br>50/60Hz | ≥90<br>≥97 | Triac<br>Dali<br>0/1-10V |

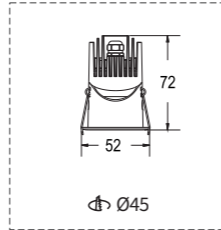

| Model Code | Power | LED Current | Lumen (±5%) | Beam angle  | Input voltage         | CRI        | Dimming                  |
|------------|-------|-------------|-------------|---|-----------------------|------------|--------------------------|
| SLO7R55    | 9W    | 200mA       | 650 lm      | (Lens)<br>10°15°24°36° 50°<br>(Reflector)<br>15°24° 38° | AC220-240V<br>50/60Hz | ≥90<br>≥97 | Triac<br>Dali<br>0/1-10V |

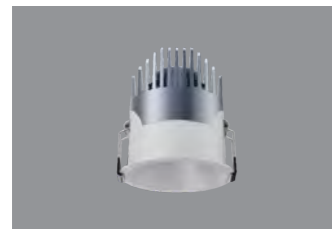
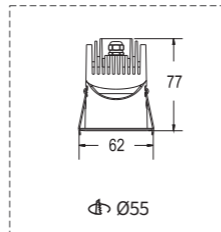



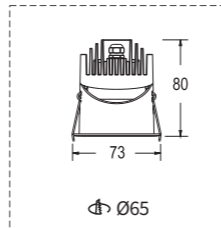



| Model Code | Power | LED Current | Lumen (±5%) | Beam angle  | Input voltage         | CRI        | Dimming                  |
|------------|-------|-------------|-------------|---|-----------------------|------------|--------------------------|
| SLO7R65    | 12W   | 300mA       | 850 lm      | (Lens)<br>10°15°24°36° 50°<br>(Reflector)<br>15°24° 38° | AC220-240V<br>50/60Hz | ≥90<br>≥97 | Triac<br>Dali<br>0/1-10V |



- Swivel angle:  
 30°
- CCT:  
2700K/3000K/3500K/4000K/5700K
- Finish:  
White/Black
- Light source:  
COB LED  
Luminus/CREE/Bridgelux



- Colour:           Optional:  Honey comb

SHADOW



| Model Code | Power | LED Current | Lumen (±5%) | Beam angle  | Input voltage         | CRI        | Dimming                  |
|------------|-------|-------------|-------------|---|-----------------------|------------|--------------------------|
| SLO7R75    | 15W   | 350mA       | 1150 lm     | (Lens)<br>10°15°24°36° 50°<br>(Reflector)<br>15°24° 38° | AC220-240V<br>50/60Hz | ≥90<br>≥97 | Triac<br>Dali<br>0/1-10V |

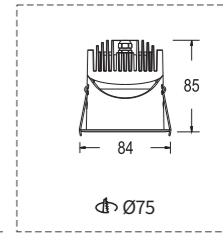

| Model Code | Power | LED Current | Lumen (±5%) | Beam angle  | Input voltage         | CRI        | Dimming                  |
|------------|-------|-------------|-------------|---|-----------------------|------------|--------------------------|
| SLO7R95    | 30W   | 750mA       | 2650 lm     | (Lens)<br>10°15°24°36° 50°<br>(Reflector)<br>15°24° 38° | AC220-240V<br>50/60Hz | ≥90<br>≥97 | Triac<br>Dali<br>0/1-10V |

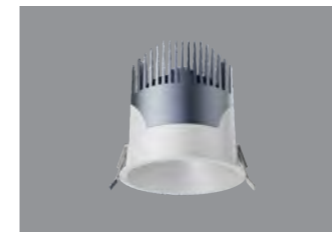
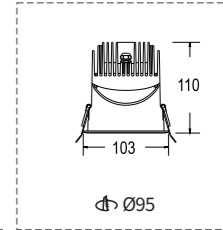



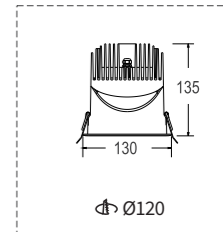

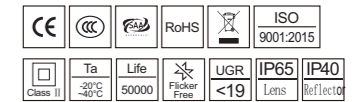

| Model Code | Power | LED Current | Lumen (±5%) | Beam angle  | Input voltage         | CRI        | Dimming                  |
|------------|-------|-------------|-------------|---|-----------------------|------------|--------------------------|
| SLO7R120   | 38W   | 950mA       | 3300 lm     | (Lens)<br>10°15°24°36° 50°<br>(Reflector)<br>15°24° 38° | AC220-240V<br>50/60Hz | ≥90<br>≥97 | Triac<br>Dali<br>0/1-10V |



- Swivel angle:  
 30°
- CCT:  
2700K/3000K/3500K/4000K/5700K
- Finish:  
White/Black
- Light source:  
COB LED  
Luminus/CREE/Bridgelux



- Colour:           Optional:  Honey comb



# KUDORA

## IP54 LED SPOT LIGHT

KUDORA WATERPROOF SPOTLIGHT WITH BRAND COB CHIP AND DIE-CASTING ALUMINUM HOUSING.  
 FLICKER FREE AND EXTERNAL DRIVER DESIGN  
 IP54 FOR FRONT AND UGR<16 ARE AVAILABLE



### SPLIT STRUCTURE

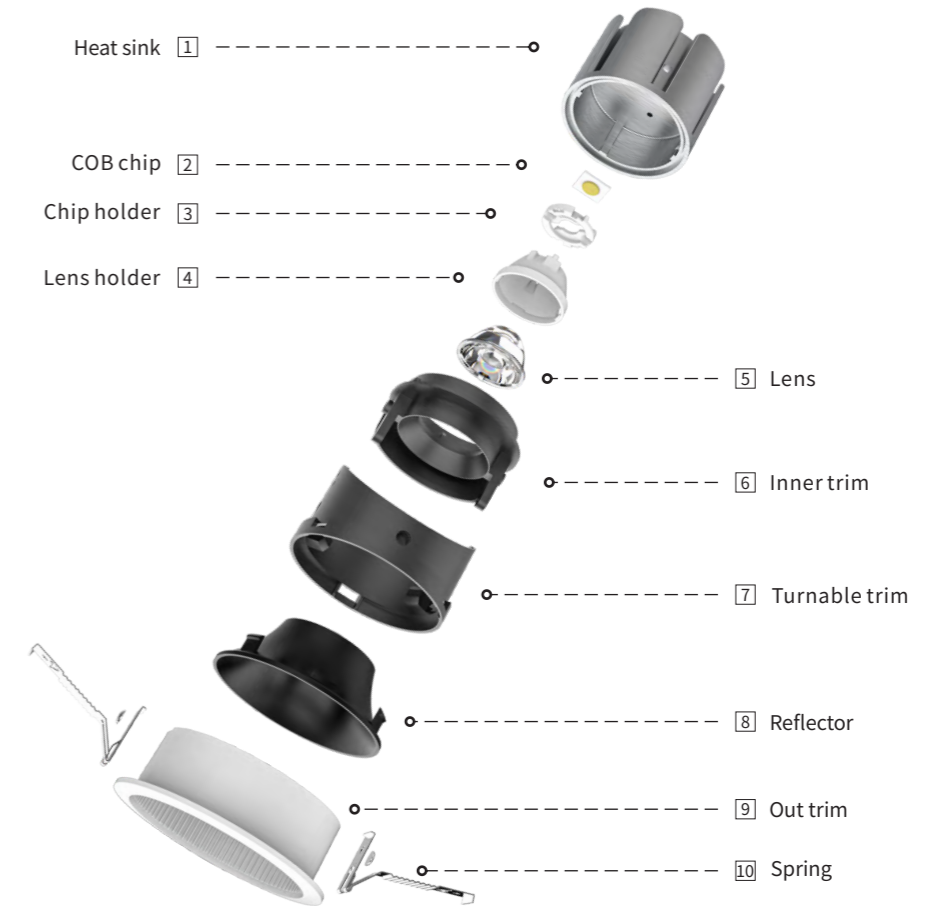

### Available in 4 colors





| Model Code | Power | LED Current | Lumen (±5%) | Beam angle                | Input voltage         | CRI        | Dimming                  |
|------------|-------|-------------|-------------|---------------------------|-----------------------|------------|--------------------------|
| SL01R55    | 7W    | 180mA       | 600 lm      | 8° 15° 24°<br>36° 45° 60° | AC220-240V<br>50/60Hz | ≥90<br>≥97 | Triac<br>Dali<br>0/1-10V |

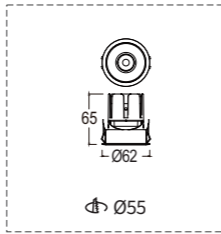

| Model Code | Power | LED Current | Lumen (±5%) | Beam angle                | Input voltage         | CRI        | Dimming                  |
|------------|-------|-------------|-------------|---------------------------|-----------------------|------------|--------------------------|
| SL01R75    | 12W   | 300mA       | 1050 lm     | 8° 15° 24°<br>36° 45° 60° | AC220-240V<br>50/60Hz | ≥90<br>≥97 | Triac<br>Dali<br>0/1-10V |

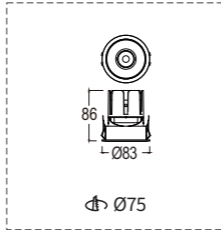

| Model Code | Power | LED Current | Lumen (±5%) | Beam angle                | Input voltage         | CRI        | Dimming                  |
|------------|-------|-------------|-------------|---------------------------|-----------------------|------------|--------------------------|
| SL01S75    | 12W   | 300mA       | 1050 lm     | 8° 15° 24°<br>36° 45° 60° | AC220-240V<br>50/60Hz | ≥90<br>≥97 | Triac<br>Dali<br>0/1-10V |

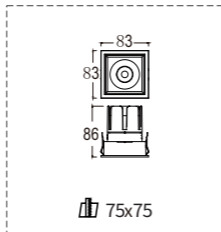

| Model Code | Power | LED Current | Lumen (±5%) | Beam angle                | Input voltage         | CRI        | Dimming                  |
|------------|-------|-------------|-------------|---------------------------|-----------------------|------------|--------------------------|
| SL01R95    | 20W   | 500mA       | 1850 lm     | 8° 15° 24°<br>36° 45° 60° | AC220-240V<br>50/60Hz | ≥90<br>≥97 | Triac<br>Dali<br>0/1-10V |

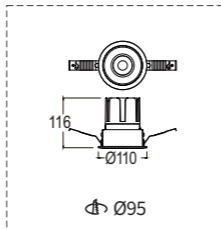

- **Swivel angle:**
- **CCT:**  
2700K/3000K/3500K/4000K/5700K
- **Finish:**  
White/Black
- **Light source:**  
COB LED  
Luminus/CREE/Bridgelux



| Model Code | Power | LED Current | Lumen (±5%) | Beam angle                | Input voltage         | CRI        | Dimming                  |
|------------|-------|-------------|-------------|---------------------------|-----------------------|------------|--------------------------|
| SL01RT55   | 7W    | 180mA       | 600 lm      | 8° 15° 24°<br>36° 45° 60° | AC220-240V<br>50/60Hz | ≥90<br>≥97 | Triac<br>Dali<br>0/1-10V |

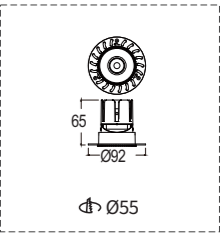

| Model Code | Power | LED Current | Lumen (±5%) | Beam angle                | Input voltage         | CRI        | Dimming                  |
|------------|-------|-------------|-------------|---------------------------|-----------------------|------------|--------------------------|
| SL01RT75   | 12W   | 300mA       | 1050 lm     | 8° 15° 24°<br>36° 45° 60° | AC220-240V<br>50/60Hz | ≥90<br>≥97 | Triac<br>Dali<br>0/1-10V |

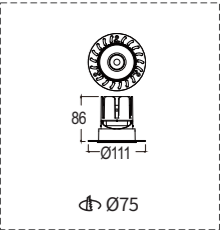

| Model Code | Power | LED Current | Lumen (±5%) | Beam angle                | Input voltage         | CRI        | Dimming                  |
|------------|-------|-------------|-------------|---------------------------|-----------------------|------------|--------------------------|
| SL01RT95   | 20W   | 500mA       | 1850 lm     | 8° 15° 24°<br>36° 45° 60° | AC220-240V<br>50/60Hz | ≥90<br>≥97 | Triac<br>Dali<br>0/1-10V |

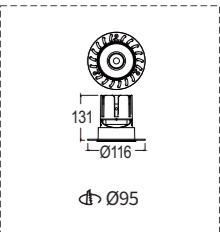

- **Swivel angle:**
- **CCT:**  
2700K/3000K/3500K/4000K/5700K
- **Finish:**  
White/Black
- **Light source:**  
COB LED  
Luminus/CREE/Bridgelux

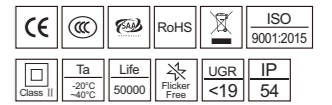



# MAMBA

## LED SPOT LIGHT

THE MAMBA SERIES IS WITH 5 TYPES REFLECTORS FOR OPTION  
 IT ADOPTS HIGH LUMEN COB CHIP , ANTI-GLARE PC LENS WITH GREAT LIGHTING DISTRIBUTION.  
 DIEC-CASTING ALUMINUM HEAT SINK PROVIDES GREAT HEAT DISSIPATION

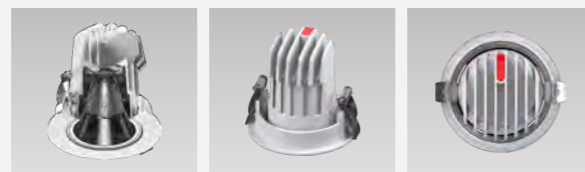

## SPLIT STRUCTURE

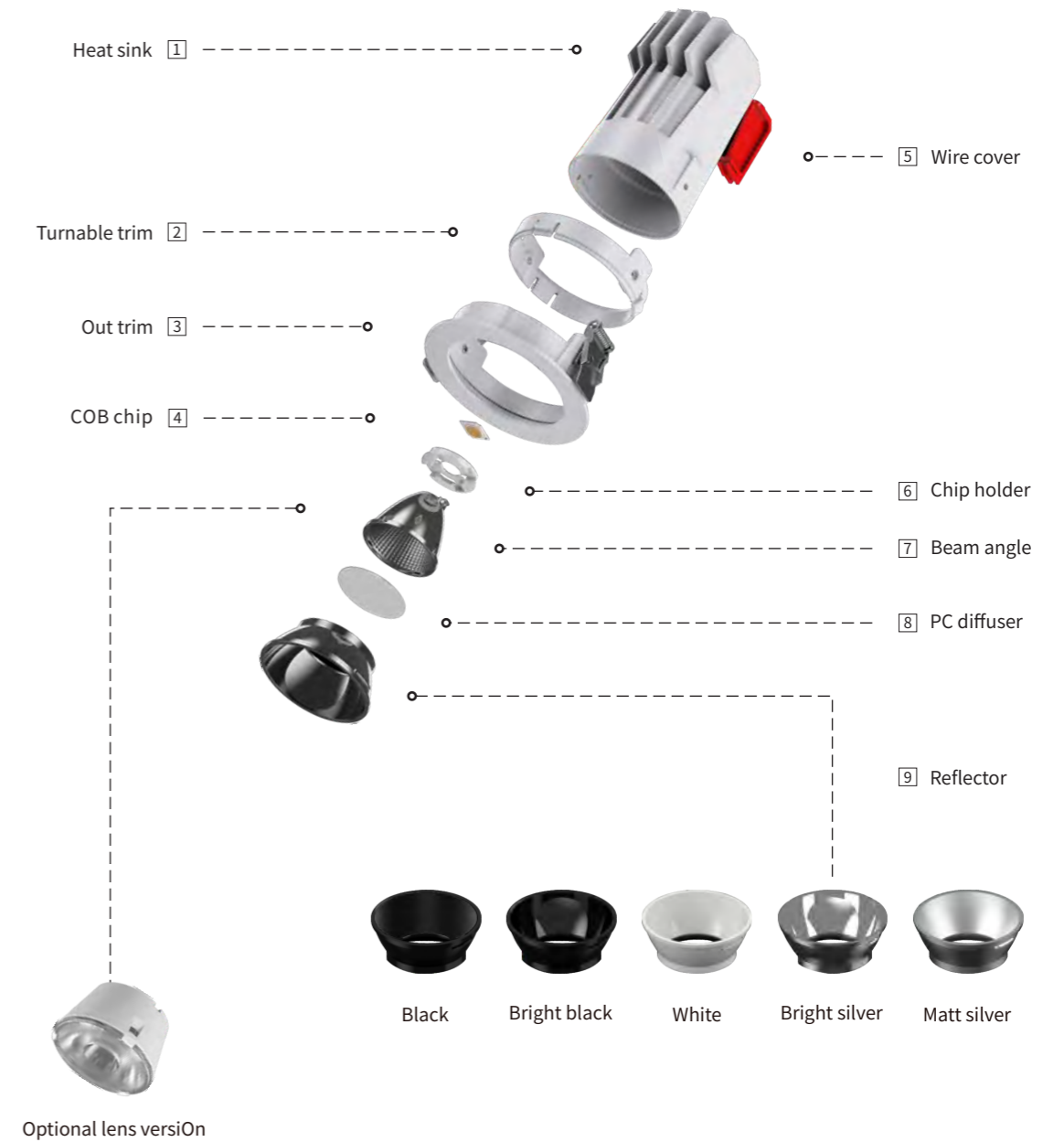



| Model Code | Power | LED Current | Lumen (±5%) | Beam angle  | Input voltage         | CRI        | Dimming                  |
|------------|-------|-------------|-------------|-------------|-----------------------|------------|--------------------------|
| SL10R75    | 12W   | 300mA       | 1050 lm     | 15° 24° 38° | AC220-240V<br>50/60Hz | ≥90<br>≥97 | Triac<br>Dali<br>0/1-10V |

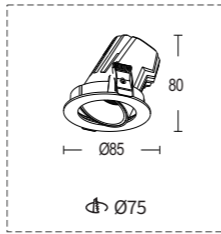

● Swivel angle:



● CCT:

2700K/3000K/3500K/4000K/5700K

● Finish:

White/Black

● Light source:

COB LED  
Luminus/CREE/Bridgelux

| Model Code | Power | LED Current | Lumen (±5%) | Beam angle  | Input voltage         | CRI        | Dimming                  |
|------------|-------|-------------|-------------|-------------|-----------------------|------------|--------------------------|
| SL10R95    | 20W   | 500mA       | 1800 lm     | 15° 24° 38° | AC220-240V<br>50/60Hz | ≥90<br>≥97 | Triac<br>Dali<br>0/1-10V |

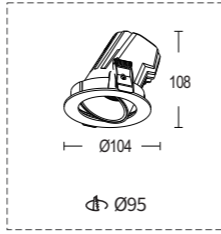

| Model Code | Power | LED Current | Lumen (±5%) | Beam angle  | Input voltage         | CRI        | Dimming                  |
|------------|-------|-------------|-------------|-------------|-----------------------|------------|--------------------------|
| SL10R125   | 30W   | 700mA       | 2750 lm     | 15° 24° 38° | AC220-240V<br>50/60Hz | ≥90<br>≥97 | Triac<br>Dali<br>0/1-10V |

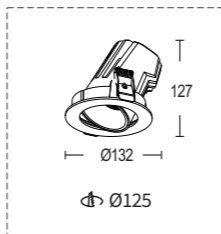

Colour:

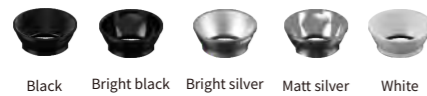

Optic:



| Model Code | Power | LED Current | Lumen (±5%) | Beam angle      | Input voltage         | CRI        | Dimming                  |
|------------|-------|-------------|-------------|-----------------|-----------------------|------------|--------------------------|
| SL11R75    | 25W   | 600mA       | 2500 lm     | 12° 24° 36° 60° | AC220-240V<br>50/60Hz | ≥90<br>≥97 | Triac<br>Dali<br>0/1-10V |

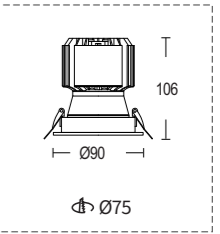

● Swivel angle:



● CCT:

2700K/3000K/3500K/4000K/5700K

● Finish:

White/Black

● Light source:

COB LED  
Luminus/CREE/Bridgelux

| Model Code | Power | LED Current | Lumen (±5%) | Beam angle      | Input voltage         | CRI        | Dimming                  |
|------------|-------|-------------|-------------|-----------------|-----------------------|------------|--------------------------|
| SL11R95    | 35W   | 850mA       | 3500 lm     | 12° 24° 36° 60° | AC220-240V<br>50/60Hz | ≥90<br>≥97 | Triac<br>Dali<br>0/1-10V |

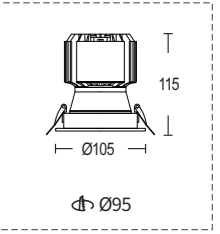



# HERON

## LED SPOT LIGHT

THE HERON SERIES ADOPTS WITH AL6063 ALUMINIUM HEATSINK  
IT HAS SUPER GREAT HEAT DISSAPTION EFFECT  
DIFFERENT COLOR OF FRONT REFLECTOR DESIGN EFFECTIVELY REDUCES THE GLARE



| Model Code | Power | LED Current | Lumen (±5%) | Beam angle  | Input voltage         | CRI        | Dimming                  |
|------------|-------|-------------|-------------|-------------|-----------------------|------------|--------------------------|
| SL18R55    | 7W    | 180mA       | 550 lm      | 15° 24° 36° | AC220-240V<br>50/60Hz | ≥90<br>≥97 | Triac<br>Dali<br>0/1-10V |

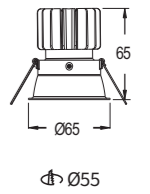

- **CCT:**  
2700K/3000K/3500K/4000K/5700K
- **Finish:**  
White/Black/Grey
- **Light source:**  
COB LED  
Luminus/CREE/Bridgelux

| Model Code | Power | LED Current | Lumen (±5%) | Beam angle  | Input voltage         | CRI        | Dimming                  |
|------------|-------|-------------|-------------|-------------|-----------------------|------------|--------------------------|
| SL18R75    | 12W   | 300mA       | 950 lm      | 15° 24° 36° | AC220-240V<br>50/60Hz | ≥90<br>≥97 | Triac<br>Dali<br>0/1-10V |

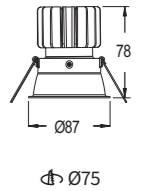

| Model Code | Power | LED Current | Lumen (±5%) | Beam angle  | Input voltage         | CRI        | Dimming                  |
|------------|-------|-------------|-------------|-------------|-----------------------|------------|--------------------------|
| SL18R95    | 18W   | 450mA       | 1450 lm     | 15° 24° 36° | AC220-240V<br>50/60Hz | ≥90<br>≥97 | Triac<br>Dali<br>0/1-10V |

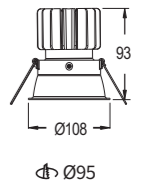

| Model Code | Power | LED Current | Lumen (±5%) | Beam angle  | Input voltage         | CRI        | Dimming                  |
|------------|-------|-------------|-------------|-------------|-----------------------|------------|--------------------------|
| SL18R125   | 30W   | 700mA       | 2850 lm     | 15° 24° 36° | AC220-240V<br>50/60Hz | ≥90<br>≥97 | Triac<br>Dali<br>0/1-10V |

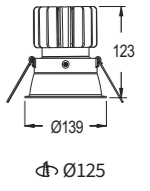

| Model Code | Power | LED Current | Lumen (±5%) | Beam angle  | Input voltage         | CRI        | Dimming                  |
|------------|-------|-------------|-------------|-------------|-----------------------|------------|--------------------------|
| SL18R135   | 40W   | 950mA       | 3850 lm     | 15° 24° 36° | AC220-240V<br>50/60Hz | ≥90<br>≥97 | Triac<br>Dali<br>0/1-10V |

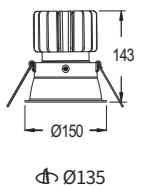

Colour:  Sand white  Sand black

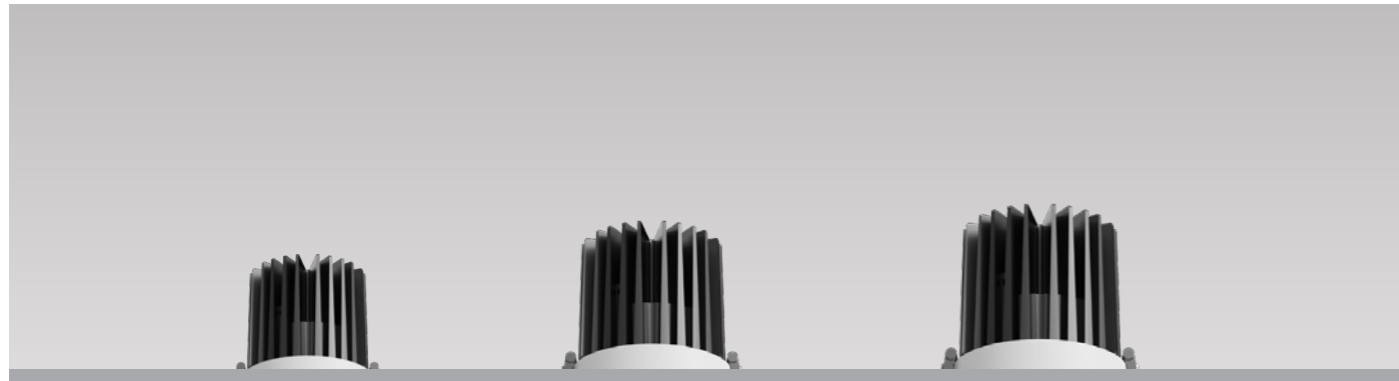

# GRACE

## LED SPOT LIGHT

THE HERON SERIES ADOPTS WITH DIE-CASTING ALUMINIUM HEATSINK  
IT HAS SUPER GREAT HEAT DISSAPTION EFFECT  
TWO DESIGN OF FRONT TRIM WITH REFLECTOR OR WITHOUT REFLECTOR FOR OPTIONS



| Model Code | Power | LED Current | Lumen (±5%) | Beam angle  | Input voltage         | CRI        | Dimming                  |
|------------|-------|-------------|-------------|-------------|-----------------------|------------|--------------------------|
| SL14R55    | 7W    | 150mA       | 550 lm      | 15° 24° 38° | AC220-240V<br>50/60Hz | ≥90<br>≥97 | Triac<br>Dali<br>0/1-10V |

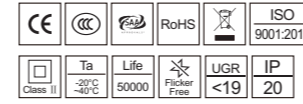
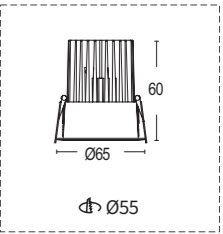

- **CCT:**  
3000K/3500K/4000K/5700K
- **Finish:**  
White/Black
- **Light source:**  
COB LED  
Luminus/CREE/Bridgelux

| Model Code | Power | LED Current | Lumen (±5%) | Beam angle  | Input voltage         | CRI        | Dimming                  |
|------------|-------|-------------|-------------|-------------|-----------------------|------------|--------------------------|
| SL14R75    | 12W   | 300mA       | 1050 lm     | 15° 24° 38° | AC220-240V<br>50/60Hz | ≥90<br>≥97 | Triac<br>Dali<br>0/1-10V |

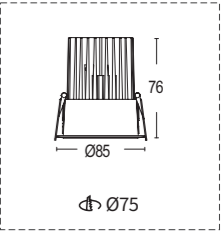

| Model Code | Power | LED Current | Lumen (±5%) | Beam angle  | Input voltage         | CRI        | Dimming                  |
|------------|-------|-------------|-------------|-------------|-----------------------|------------|--------------------------|
| SL14R95    | 25W   | 600mA       | 2070 lm     | 15° 24° 38° | AC220-240V<br>50/60Hz | ≥90<br>≥97 | Triac<br>Dali<br>0/1-10V |

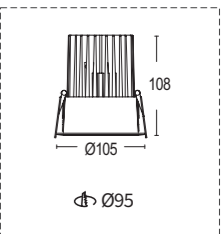

Colour:  White  Black  Silver  Chrome black

Accessory:  Honeycomb



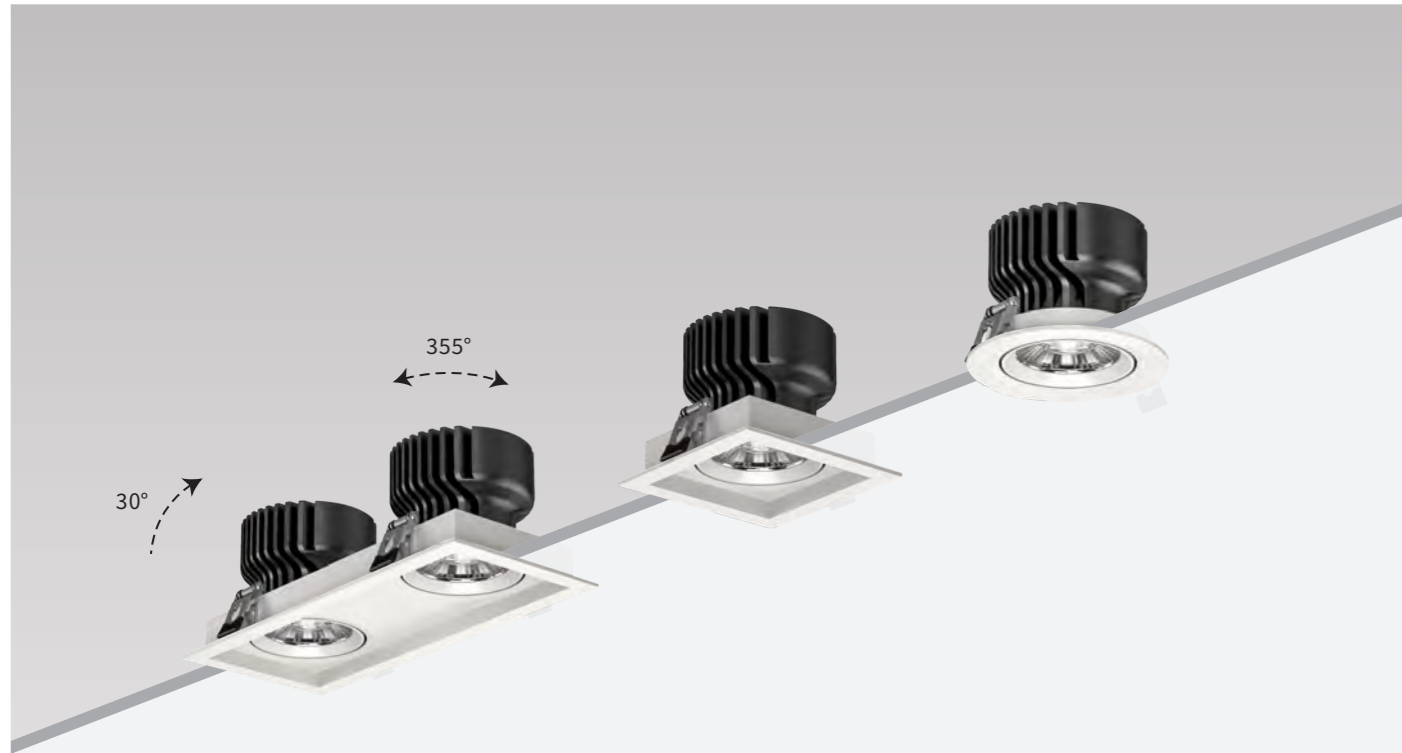

# TIDA

## LED SPOT LIGHT

THE LIGHT BODY IS DESIGNED WITH MODULAR STRUCTURE  
AND CAN ROTATE 355° AND SWING UP AND DOWN 30°  
BESIDES THIS RANGE IS AVAILABLE IN ROUND & SQUARE STYLES FOR OPTIONS



### Modular combination

25W / 35W

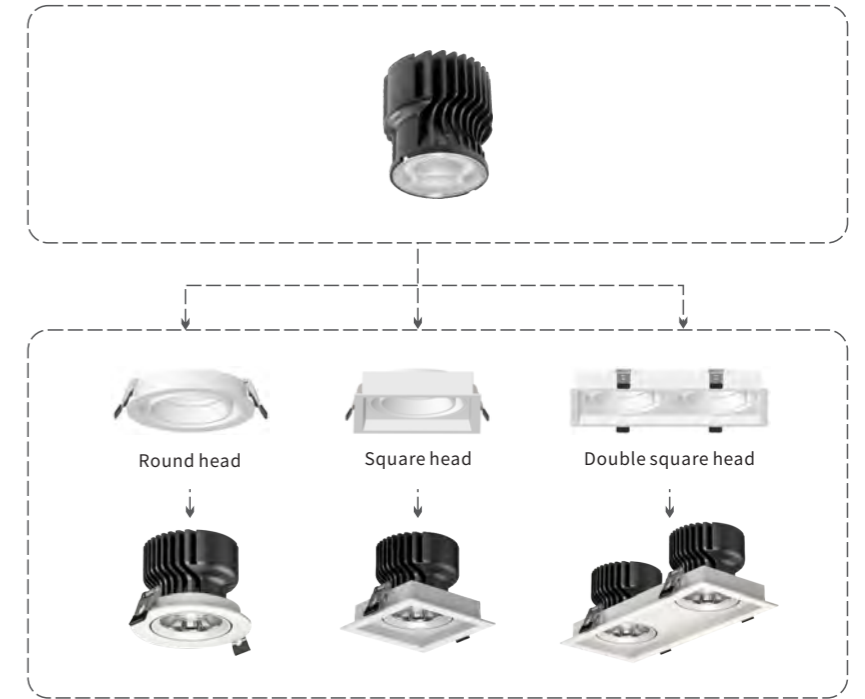

### HD lens performance

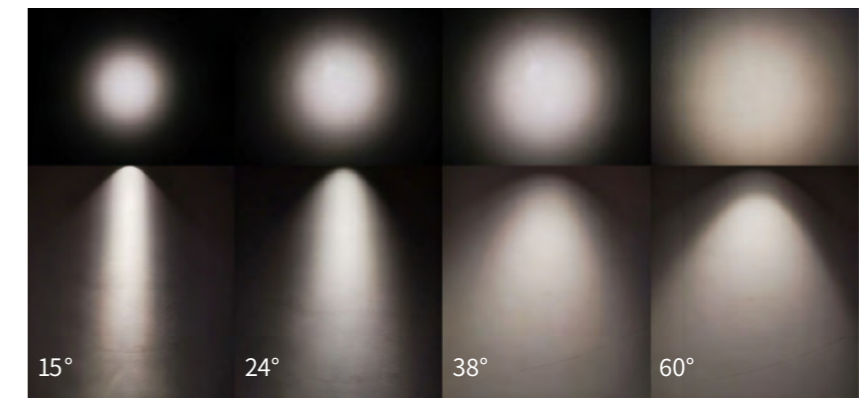



| Model Code | Power | LED Current | Lumen (±5%) | Beam angle      | Input voltage         | CRI        | Dimming                  |
|------------|-------|-------------|-------------|-----------------|-----------------------|------------|--------------------------|
| SL3310     | 25W   | 600mA       | 2375 lm     | 15° 24° 38° 60° | AC220-240V<br>50/60Hz | ≥90<br>≥97 | Triac<br>Dali<br>0/1-10V |

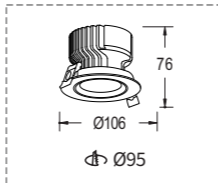

|        |     |       |         |                 |                       |            |                          |
|--------|-----|-------|---------|-----------------|-----------------------|------------|--------------------------|
| SL3311 | 35W | 850mA | 3475 lm | 15° 24° 38° 60° | AC220-240V<br>50/60Hz | ≥90<br>≥97 | Triac<br>Dali<br>0/1-10V |
|--------|-----|-------|---------|-----------------|-----------------------|------------|--------------------------|

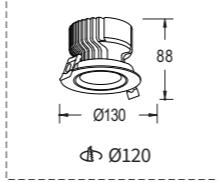

| Model Code | Power | LED Current | Lumen (±5%) | Beam angle      | Input voltage         | CRI        | Dimming                  |
|------------|-------|-------------|-------------|-----------------|-----------------------|------------|--------------------------|
| SL3310S    | 25W   | 600mA       | 2375 lm     | 15° 24° 38° 60° | AC220-240V<br>50/60Hz | ≥90<br>≥97 | Triac<br>Dali<br>0/1-10V |

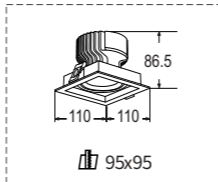

|         |     |       |         |                 |                       |            |                          |
|---------|-----|-------|---------|-----------------|-----------------------|------------|--------------------------|
| SL3311S | 35W | 850mA | 3475 lm | 15° 24° 38° 60° | AC220-240V<br>50/60Hz | ≥90<br>≥97 | Triac<br>Dali<br>0/1-10V |
|---------|-----|-------|---------|-----------------|-----------------------|------------|--------------------------|

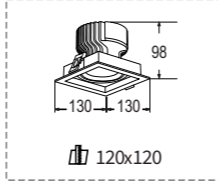

| Model Code | Power | LED Current | Lumen (±5%) | Beam angle      | Input voltage         | CRI        | Dimming                  |
|------------|-------|-------------|-------------|-----------------|-----------------------|------------|--------------------------|
| SL3310S-2  | 2x25W | 600mA       | 4700 lm     | 15° 24° 38° 60° | AC220-240V<br>50/60Hz | ≥90<br>≥97 | Triac<br>Dali<br>0/1-10V |

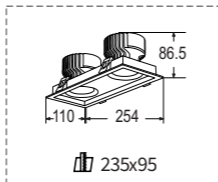

|           |       |       |         |                 |                       |            |                          |
|-----------|-------|-------|---------|-----------------|-----------------------|------------|--------------------------|
| SL3311S-2 | 2x35W | 850mA | 6900 lm | 15° 24° 38° 60° | AC220-240V<br>50/60Hz | ≥90<br>≥97 | Triac<br>Dali<br>0/1-10V |
|-----------|-------|-------|---------|-----------------|-----------------------|------------|--------------------------|

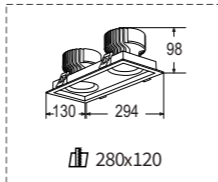

|          |                      |               |                 |            |          |
|----------|----------------------|---------------|-----------------|------------|----------|
| Class II | Ta<br>-20°C<br>-40°C | Life<br>50000 | Flicker<br>Free | UGR<br><19 | IP<br>20 |
|----------|----------------------|---------------|-----------------|------------|----------|

● Swivel angle:



● CCT:  
2700K/3000K/3500K/4000K/5700K

● Finish:  
White/Black

● Light source:  
COB LED  
Luminus/CREE/Bridgelux



Module Engine



| Model Code | Power | LED Current | Lumen (±5%) | Beam angle      | Input voltage         | CRI        | Dimming                  |
|------------|-------|-------------|-------------|-----------------|-----------------------|------------|--------------------------|
| SL3312     | 25W   | 600mA       | 2375 lm     | 15° 24° 38° 60° | AC220-240V<br>50/60Hz | ≥90<br>≥97 | Triac<br>Dali<br>0/1-10V |

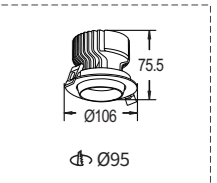

|        |     |       |         |                 |                       |            |                          |
|--------|-----|-------|---------|-----------------|-----------------------|------------|--------------------------|
| SL3313 | 35W | 850mA | 3475 lm | 15° 24° 38° 60° | AC220-240V<br>50/60Hz | ≥90<br>≥97 | Triac<br>Dali<br>0/1-10V |
|--------|-----|-------|---------|-----------------|-----------------------|------------|--------------------------|

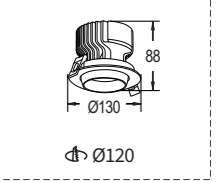

| Model Code | Power | LED Current | Lumen (±5%) | Beam angle      | Input voltage         | CRI        | Dimming                  |
|------------|-------|-------------|-------------|-----------------|-----------------------|------------|--------------------------|
| SL3312S    | 25W   | 600mA       | 2375 lm     | 15° 24° 38° 60° | AC220-240V<br>50/60Hz | ≥90<br>≥97 | Triac<br>Dali<br>0/1-10V |

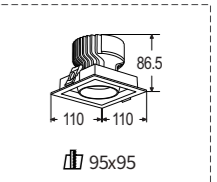

|         |     |       |         |                 |                       |            |                          |
|---------|-----|-------|---------|-----------------|-----------------------|------------|--------------------------|
| SL3313S | 35W | 850mA | 3475 lm | 15° 24° 38° 60° | AC220-240V<br>50/60Hz | ≥90<br>≥97 | Triac<br>Dali<br>0/1-10V |
|---------|-----|-------|---------|-----------------|-----------------------|------------|--------------------------|

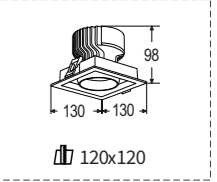

| Model Code | Power | LED Current | Lumen (±5%) | Beam angle      | Input voltage         | CRI        | Dimming                  |
|------------|-------|-------------|-------------|-----------------|-----------------------|------------|--------------------------|
| SL3312S-2  | 2x25W | 600mA       | 4700 lm     | 15° 24° 38° 60° | AC220-240V<br>50/60Hz | ≥90<br>≥97 | Triac<br>Dali<br>0/1-10V |

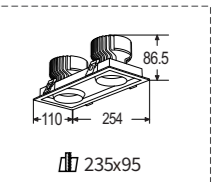

|           |       |       |         |                 |                       |            |                          |
|-----------|-------|-------|---------|-----------------|-----------------------|------------|--------------------------|
| SL3313S-2 | 2x35W | 850mA | 6900 lm | 15° 24° 38° 60° | AC220-240V<br>50/60Hz | ≥90<br>≥97 | Triac<br>Dali<br>0/1-10V |
|-----------|-------|-------|---------|-----------------|-----------------------|------------|--------------------------|

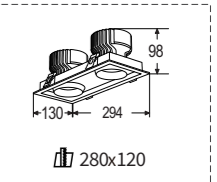

|          |                      |               |                 |            |          |
|----------|----------------------|---------------|-----------------|------------|----------|
| Class II | Ta<br>-20°C<br>-40°C | Life<br>50000 | Flicker<br>Free | UGR<br><19 | IP<br>20 |
|----------|----------------------|---------------|-----------------|------------|----------|

● Swivel angle:



● CCT:  
2700K/3000K/3500K/4000K/5700K

● Finish:  
White/Black

● Light source:  
COB LED  
Luminus/CREE/Bridgelux



Module Engine



| Model Code | Power | LED Current | Lumen (±5%) | Beam angle  | Input voltage         | CRI        | Dimming                  |
|------------|-------|-------------|-------------|-------------|-----------------------|------------|--------------------------|
| SL805      | 32W   | 800mA       | 3200 lm     | 15° 24° 38° | AC220-240V<br>50/60Hz | ≥90<br>≥97 | Triac<br>Dali<br>0/1-10V |

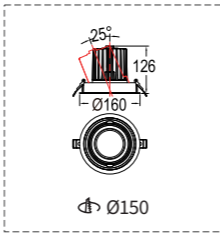

| Model Code | Power | LED Current | Lumen (±5%) | Beam angle  | Input voltage         | CRI        | Dimming                  |
|------------|-------|-------------|-------------|-------------|-----------------------|------------|--------------------------|
| SL805S     | 32W   | 800mA       | 3200 lm     | 15° 24° 38° | AC220-240V<br>50/60Hz | ≥90<br>≥97 | Triac<br>Dali<br>0/1-10V |

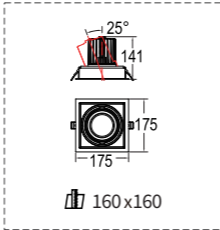

| Model Code | Power | LED Current | Lumen (±5%) | Beam angle  | Input voltage         | CRI        | Dimming                  |
|------------|-------|-------------|-------------|-------------|-----------------------|------------|--------------------------|
| SL805S-2   | 2x32W | 800mA       | 6400 lm     | 15° 24° 38° | AC220-240V<br>50/60Hz | ≥90<br>≥97 | Triac<br>Dali<br>0/1-10V |

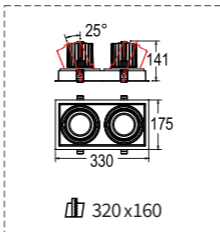

● Swivel angle:



● CCT:

2700K/3000K/3500K/4000K/5700K

● Finish:

White/Black

● Light source:

COB LED  
Luminus/CREE/Bridgelux



ModuleEngine





For different height requirements

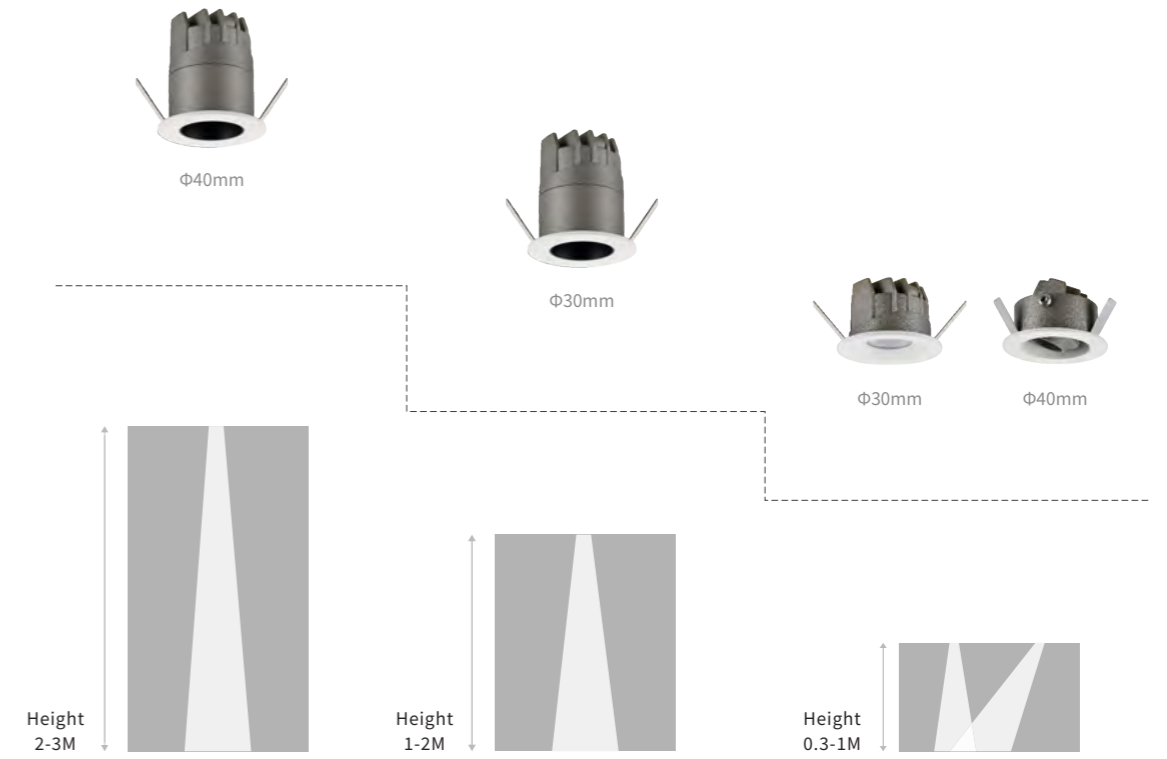

Fixtures layout advise





| Model Code | Power | LED Current | Lumen (±5%) | Beam angle  | Input voltage         | CRI        | Dimming                  |
|------------|-------|-------------|-------------|-------------|-----------------------|------------|--------------------------|
| SL003      | 2W    | 350mA       | 90 lm       | 15° 24° 36° | AC220-240V<br>50/60Hz | ≥90<br>≥97 | Triac<br>Dali<br>0/1-10V |

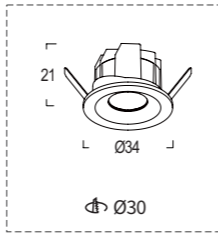

| Model Code | Power | LED Current | Lumen (±5%) | Beam angle | Input voltage         | CRI        | Dimming                  |
|------------|-------|-------------|-------------|------------|-----------------------|------------|--------------------------|
| SL003H     | 3W    | 700mA       | 130 lm      | 15° 24°    | AC220-240V<br>50/60Hz | ≥90<br>≥97 | Triac<br>Dali<br>0/1-10V |

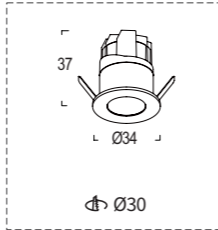

| Model Code | Power | LED Current | Lumen (±5%) | Beam angle  | Input voltage         | CRI        | Dimming                  |
|------------|-------|-------------|-------------|-------------|-----------------------|------------|--------------------------|
| SL004      | 2W    | 350mA       | 90 lm       | 15° 24° 36° | AC220-240V<br>50/60Hz | ≥90<br>≥97 | Triac<br>Dali<br>0/1-10V |

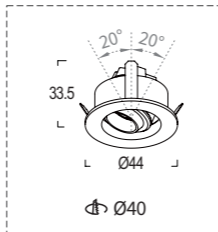

| Model Code | Power | LED Current | Lumen (±5%) | Beam angle | Input voltage         | CRI        | Dimming                  |
|------------|-------|-------------|-------------|------------|-----------------------|------------|--------------------------|
| SL004H     | 3W    | 700mA       | 215 lm      | 15° 24°    | AC220-240V<br>50/60Hz | ≥90<br>≥97 | Triac<br>Dali<br>0/1-10V |

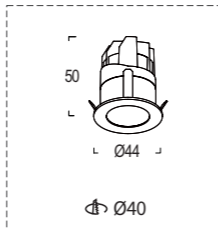

- **CCT:**  
2700K/3000K/3500K/4000K/5700K
- **Finish:**  
White/Black
- **Light source:**  
COB LED  
Luminus/CREE/Bridgelux



| Model Code | Power | LED Current | Lumen (±5%) | Beam angle  | Input voltage         | CRI        | Dimming                  |
|------------|-------|-------------|-------------|-------------|-----------------------|------------|--------------------------|
| SL02R30    | 3W    | 700mA       | 120 lm      | 15° 25° 35° | AC220-240V<br>50/60Hz | ≥90<br>≥97 | Triac<br>Dali<br>0/1-10V |

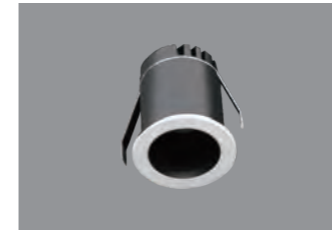
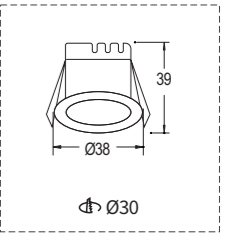

| Model Code | Power | LED Current | Lumen (±5%) | Beam angle  | Input voltage         | CRI        | Dimming                  |
|------------|-------|-------------|-------------|-------------|-----------------------|------------|--------------------------|
| SL02R40    | 5W    | 120mA       | 320 lm      | 15° 25° 35° | AC220-240V<br>50/60Hz | ≥90<br>≥97 | Triac<br>Dali<br>0/1-10V |

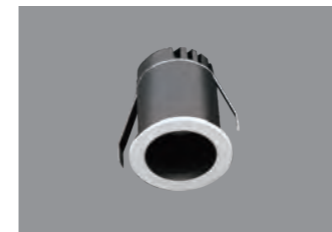
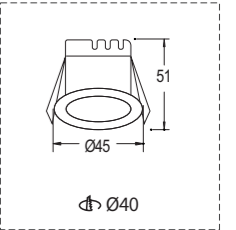

| Model Code | Power | LED Current | Lumen (±5%) | Beam angle  | Input voltage         | CRI        | Dimming                  |
|------------|-------|-------------|-------------|-------------|-----------------------|------------|--------------------------|
| SL02R50    | 7W    | 150mA       | 580 lm      | 15° 25° 35° | AC220-240V<br>50/60Hz | ≥90<br>≥97 | Triac<br>Dali<br>0/1-10V |

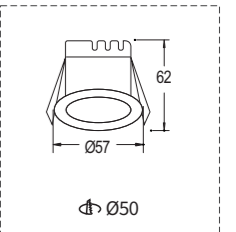

| Model Code | Power | LED Current | Lumen (±5%) | Beam angle  | Input voltage         | CRI        | Dimming                  |
|------------|-------|-------------|-------------|-------------|-----------------------|------------|--------------------------|
| SL02R60    | 9W    | 200mA       | 720 lm      | 15° 25° 35° | AC220-240V<br>50/60Hz | ≥90<br>≥97 | Triac<br>Dali<br>0/1-10V |

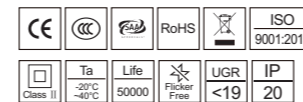
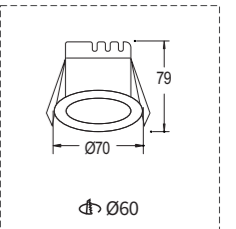

- **CCT:**  
2700K/3000K/3500K/4000K/5700K
- **Finish:**  
White/Black
- **Light source:**  
COB LED  
Luminus/CREE/Bridgelux



Beveled

Straight

Curved

Pin Hole

# STAR

## MINI SPOTLIGHT

THE STAR MINI SPOTLIGHT IS DESIGNED WITH SURFACE MOUNTED  
RECESSED MOUNTED INSTALLATIONS  
THE DIE-CASTING ALUMINIUM HEATSINK IS WITH SUPER GREAT HEAT DISSIPATION EFFECT

### Family Design

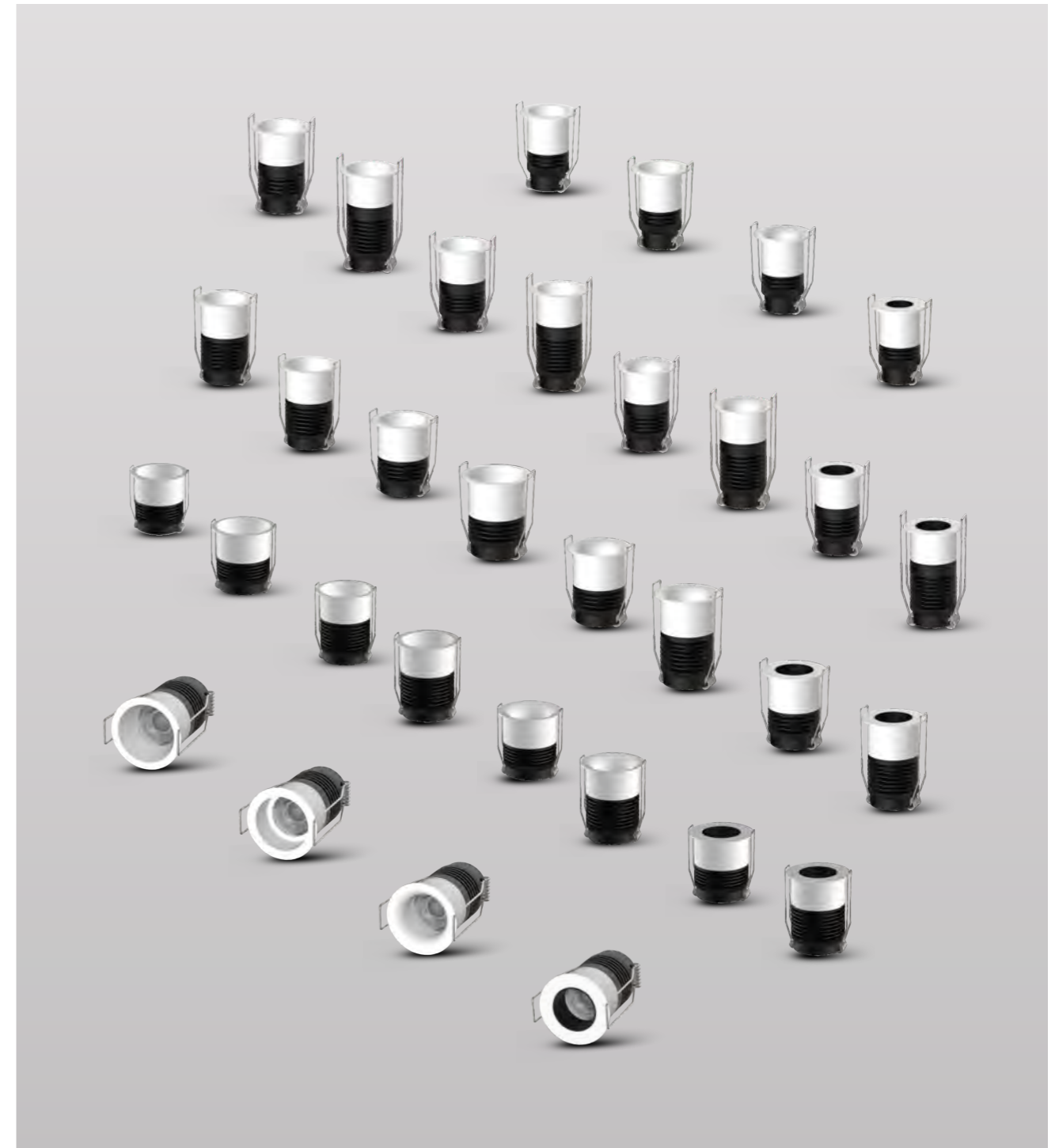



| Model Code | Power | LED Current | Lumen (±5%) | Beam angle | Input voltage         | CRI        | Dimming                  |
|------------|-------|-------------|-------------|------------|-----------------------|------------|--------------------------|
| SL15R25S   | 3.5W  | 700mA       | 193 lm      | 24° 38°    | AC220-240V<br>50/60Hz | ≥90<br>≥97 | Triac<br>Dali<br>0/1-10V |

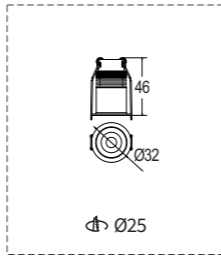

- **CCT:** 2700K/3000K/4000K/5700K
- **Finish:** White/Black
- **Light source:** SMD LED(3.5W)  
COB LED(5W/7W/9W)

|            |    |       |        |                 |                       |            |                          |
|------------|----|-------|--------|-----------------|-----------------------|------------|--------------------------|
| SL15R35S   | 5W | 120mA | 375 lm | 15° 24° 38° 55° | AC220-240V<br>50/60Hz | ≥90<br>≥97 | Triac<br>Dali<br>0/1-10V |
| SL15R35S-1 | 7W | 150mA | 525 lm |                 |                       |            |                          |

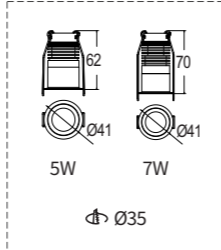

|            |    |       |        |                 |                       |            |                          |
|------------|----|-------|--------|-----------------|-----------------------|------------|--------------------------|
| SL15R45S   | 7W | 150mA | 525 lm | 15° 24° 38° 55° | AC220-240V<br>50/60Hz | ≥90<br>≥97 | Triac<br>Dali<br>0/1-10V |
| SL15R45S-1 | 9W | 200mA | 720 lm |                 |                       |            |                          |

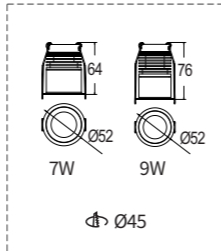

|            |     |       |         |                 |                       |            |                          |
|------------|-----|-------|---------|-----------------|-----------------------|------------|--------------------------|
| SL15R55S   | 9W  | 200mA | 720 lm  | 15° 24° 38° 55° | AC220-240V<br>50/60Hz | ≥90<br>≥97 | Triac<br>Dali<br>0/1-10V |
| SL15R45C-1 | 15W | 350mA | 1200 lm |                 |                       |            |                          |

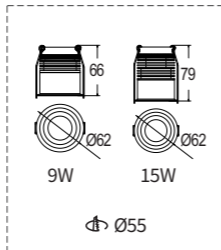

| Model Code | Power | LED Current | Lumen (±5%) | Beam angle | Input voltage         | CRI        | Dimming                  |
|------------|-------|-------------|-------------|------------|-----------------------|------------|--------------------------|
| SL15R25C   | 3.5W  | 700mA       | 193 lm      | 24° 38°    | AC220-240V<br>50/60Hz | ≥90<br>≥97 | Triac<br>Dali<br>0/1-10V |

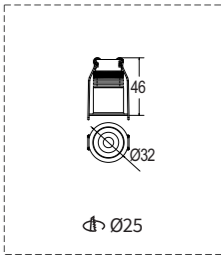

- **CCT:** 2700K/3000K/4000K/5700K
- **Finish:** White/Black
- **Light source:** SMD LED(3.5W)  
COB LED(5W/7W/9W)

|            |    |       |        |                 |                       |            |                          |
|------------|----|-------|--------|-----------------|-----------------------|------------|--------------------------|
| SL15R35C   | 5W | 120mA | 375 lm | 15° 24° 38° 55° | AC220-240V<br>50/60Hz | ≥90<br>≥97 | Triac<br>Dali<br>0/1-10V |
| SL15R35C-1 | 7W | 150mA | 525 lm |                 |                       |            |                          |

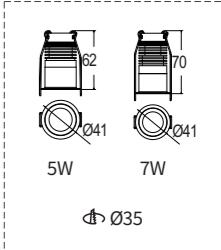

|            |    |       |        |                 |                       |            |                          |
|------------|----|-------|--------|-----------------|-----------------------|------------|--------------------------|
| SL15R45C   | 7W | 150mA | 525 lm | 15° 24° 38° 55° | AC220-240V<br>50/60Hz | ≥90<br>≥97 | Triac<br>Dali<br>0/1-10V |
| SL15R45C-1 | 9W | 200mA | 720 lm |                 |                       |            |                          |

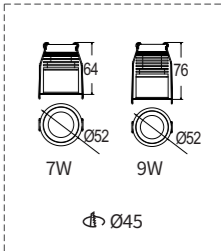

|            |     |       |         |                 |                       |            |                          |
|------------|-----|-------|---------|-----------------|-----------------------|------------|--------------------------|
| SL15R55C   | 9W  | 200mA | 720 lm  | 15° 24° 38° 55° | AC220-240V<br>50/60Hz | ≥90<br>≥97 | Triac<br>Dali<br>0/1-10V |
| SL15R45B-1 | 15W | 350mA | 1200 lm |                 |                       |            |                          |

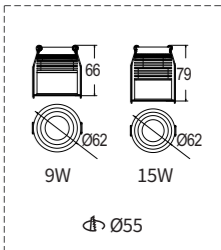



| Model Code | Power | LED Current | Lumen (±5%) | Beam angle | Input voltage         | CRI        | Dimming                  |
|------------|-------|-------------|-------------|------------|-----------------------|------------|--------------------------|
| SL15R25B   | 3.5W  | 700mA       | 193 lm      | 24° 38°    | AC220-240V<br>50/60Hz | ≥90<br>≥97 | Triac<br>Dali<br>0/1-10V |

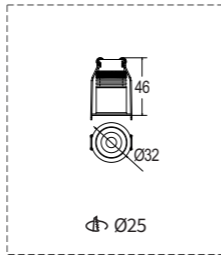

- **CCT:**  
2700K/3000K/4000K/5700K
- **Finish:**  
White/Black
- **Light source:**  
SMD LED(3.5W)  
COB LED(5W/7W/9W)

|            |    |       |        |                 |                       |            |                          |
|------------|----|-------|--------|-----------------|-----------------------|------------|--------------------------|
| SL15R35B   | 5W | 120mA | 375 lm | 15° 24° 38° 55° | AC220-240V<br>50/60Hz | ≥90<br>≥97 | Triac<br>Dali<br>0/1-10V |
| SL15R35B-1 | 7W | 150mA | 525 lm |                 |                       |            |                          |

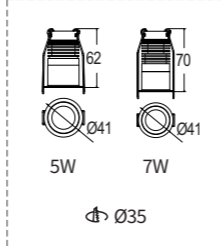

|            |    |       |        |                 |                       |            |                          |
|------------|----|-------|--------|-----------------|-----------------------|------------|--------------------------|
| SL15R45B   | 7W | 150mA | 525 lm | 15° 24° 38° 55° | AC220-240V<br>50/60Hz | ≥90<br>≥97 | Triac<br>Dali<br>0/1-10V |
| SL15R45B-1 | 9W | 200mA | 720 lm |                 |                       |            |                          |

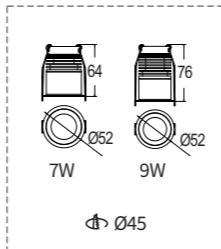

|            |     |       |         |                 |                       |            |                          |
|------------|-----|-------|---------|-----------------|-----------------------|------------|--------------------------|
| SL15R55B   | 9W  | 200mA | 720 lm  | 15° 24° 38° 55° | AC220-240V<br>50/60Hz | ≥90<br>≥97 | Triac<br>Dali<br>0/1-10V |
| SL15R45P-1 | 15W | 350mA | 1200 lm |                 |                       |            |                          |

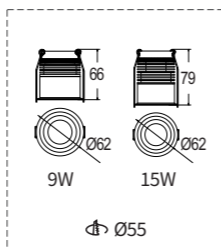

| Model Code | Power | LED Current | Lumen (±5%) | Beam angle | Input voltage         | CRI        | Dimming                  |
|------------|-------|-------------|-------------|------------|-----------------------|------------|--------------------------|
| SL15R25P   | 3.5W  | 700mA       | 193 lm      | 24° 38°    | AC220-240V<br>50/60Hz | ≥90<br>≥97 | Triac<br>Dali<br>0/1-10V |

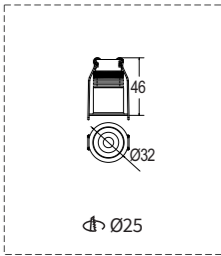

- **CCT:**  
2700K/3000K/4000K/5700K
- **Finish:**  
White/Black
- **Light source:**  
SMD LED(3.5W)  
COB LED(5W/7W/9W)

|            |    |       |        |                 |                       |            |                          |
|------------|----|-------|--------|-----------------|-----------------------|------------|--------------------------|
| SL15R35P   | 5W | 120mA | 375 lm | 15° 24° 38° 55° | AC220-240V<br>50/60Hz | ≥90<br>≥97 | Triac<br>Dali<br>0/1-10V |
| SL15R35P-1 | 7W | 150mA | 525 lm |                 |                       |            |                          |

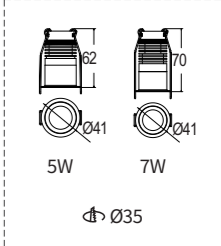

|            |    |       |        |                 |                       |            |                          |
|------------|----|-------|--------|-----------------|-----------------------|------------|--------------------------|
| SL15R45P   | 7W | 150mA | 525 lm | 15° 24° 38° 55° | AC220-240V<br>50/60Hz | ≥90<br>≥97 | Triac<br>Dali<br>0/1-10V |
| SL15R45P-1 | 9W | 200mA | 720 lm |                 |                       |            |                          |

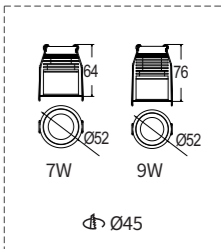

|          |     |       |         |                 |                       |            |                          |
|----------|-----|-------|---------|-----------------|-----------------------|------------|--------------------------|
| SL15R55P | 9W  | 200mA | 720 lm  | 15° 24° 38° 55° | AC220-240V<br>50/60Hz | ≥90<br>≥97 | Triac<br>Dali<br>0/1-10V |
| SL15R55S | 15W | 350mA | 1200 lm |                 |                       |            |                          |

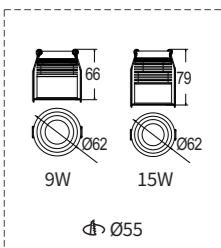



# LUMI

## MINI SPOTLIGHT

THE STAR MINI SPOTLIGHT IS DESIGNED WITH SURFACE MOUNTED  
RECESSED MOUNTED INSTALLATIONS  
THE DIE-CASTING ALUMINIUM HEATSINK IS WITH SUPER GREAT HEAT DISSIPATION EFFECT



| Model Code | Power | LED Current | Lumen (±5%) | Beam angle      | Input voltage         | CRI        | Dimming                  |
|------------|-------|-------------|-------------|-----------------|-----------------------|------------|--------------------------|
| SL50R38SM  | 6W    | 120mA       | 432 lm      | 12° 24° 36° 50° | AC220-240V<br>50/60Hz | ≥90<br>≥97 | Triac<br>Dali<br>0/1-10V |

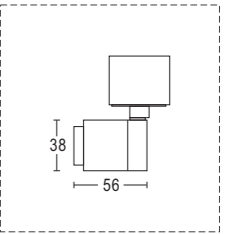

| Model Code | Power | LED Current | Lumen (±5%) | Beam angle      | Input voltage         | CRI        | Dimming                  |
|------------|-------|-------------|-------------|-----------------|-----------------------|------------|--------------------------|
| SL50R38RM  | 6W    | 120mA       | 432 lm      | 12° 24° 36° 50° | AC220-240V<br>50/60Hz | ≥90<br>≥97 | Triac<br>Dali<br>0/1-10V |

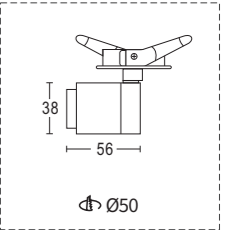

• Swivel angle:



• CCT:

2700K/3000K/3500K/4000K/5700K

• Finish:

White/Black

• Light source:

COB LED  
Luminus/CREE/Bridgelux



| Model Code | Power | LED Current | Lumen (±5%) | Beam angle | Input voltage         | CRI        | Dimming |
|------------|-------|-------------|-------------|------------|-----------------------|------------|---------|
| SL50R25RM  | 1W    | 350mA       | 40 lm       | 25° 36°    | AC220-240V<br>50/60Hz | ≥90<br>≥97 |         |

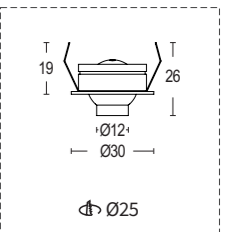

• Swivel angle:



• CCT:

2700K/3000K/3500K/4000K/5700K

• Finish:

White/Black

• Light source:

COB LED  
Luminus/CREE/Bridgelux

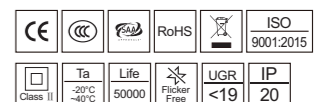

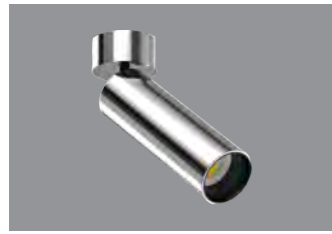

| Model Code | Power | LED Current | Lumen (±5%) | Beam angle      | Input voltage         | CRI        | Dimming |
|------------|-------|-------------|-------------|-----------------|-----------------------|------------|---------|
| SL50R32SM  | 7W    | 180mA       | 500 lm      | 15° 24° 36° 55° | AC220-240V<br>50/60Hz | ≥90<br>≥97 | /       |

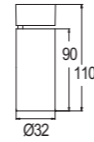

- **CCT:**  
2700K/3000K/3500K/4000K/5700K
- **Finish:**  
White/Black/Chrome
- **Light source:**  
COB LED  
Luminus/CREE/Bridgelux

| Model Code | Power | LED Current | Lumen (±5%) | Beam angle      | Input voltage         | CRI        | Dimming |
|------------|-------|-------------|-------------|-----------------|-----------------------|------------|---------|
| SL50R42SM  | 12W   | 300mA       | 950 lm      | 15° 24° 36° 55° | AC220-240V<br>50/60Hz | ≥90<br>≥97 | /       |

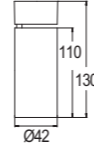

| Model Code | Power | LED Current | Lumen (±5%) | Beam angle      | Input voltage         | CRI        | Dimming                  |
|------------|-------|-------------|-------------|-----------------|-----------------------|------------|--------------------------|
| SL50R32RM  | 7W    | 180mA       | 500 lm      | 15° 24° 36° 55° | AC220-240V<br>50/60Hz | ≥90<br>≥97 | Triac<br>Dali<br>0/1-10V |

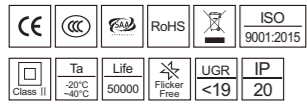

- **CCT:**  
2700K/3000K/3500K/4000K/5700K
- **Finish:**  
White/Black/Chrome
- **Light source:**  
COB LED  
Luminus/CREE/Bridgelux

| Model Code | Power | LED Current | Lumen (±5%) | Beam angle      | Input voltage         | CRI        | Dimming                  |
|------------|-------|-------------|-------------|-----------------|-----------------------|------------|--------------------------|
| SL50R42RM  | 12W   | 300mA       | 950 lm      | 15° 24° 36° 55° | AC220-240V<br>50/60Hz | ≥90<br>≥97 | Triac<br>Dali<br>0/1-10V |

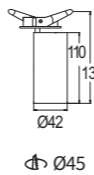



Trimmed

Trimless

# NOVA

## WALL WASHER DOWN LIGHT

THE NOVA SERIES IS ASYMMETRIC DOWNLIGHT THAT SPECIALLY DESIGNED FOR WALL WASHER EFFECT WITH A PRECISION DESIGNED WALL WASHER REFLECTOR CAN EFFECTIVELY REDUCE THE GLARE INDEX



### SPLIT STRUCTURE

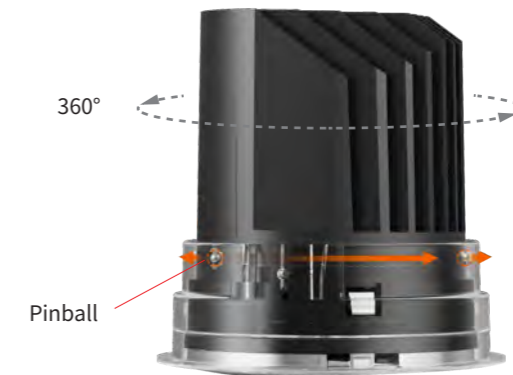
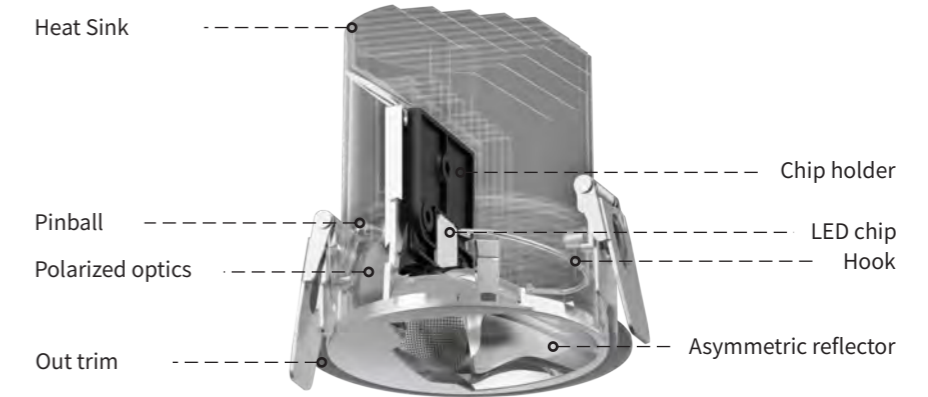

Relying on three metal pinball to achieve 360° horizontal free rotation

Removable lamp liner

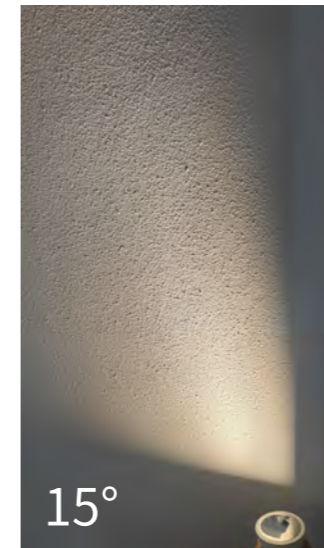
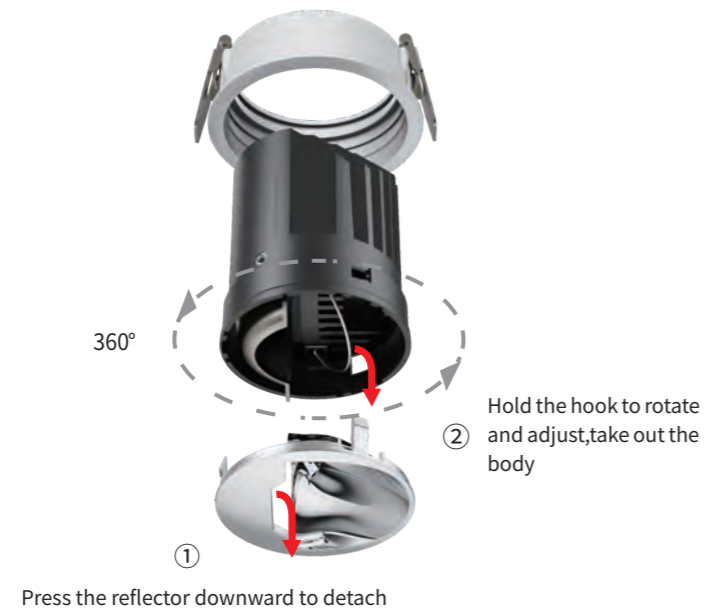

Tilting Angle: 15°

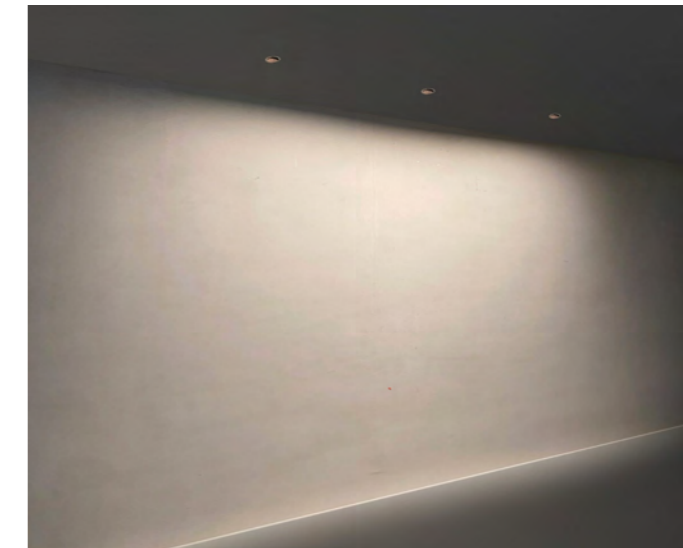

Seamless connection delivers smooth gradated light output, eliminating any bright or dark spots.

Wall washer ratio: 0.8 : 3 : 0.8

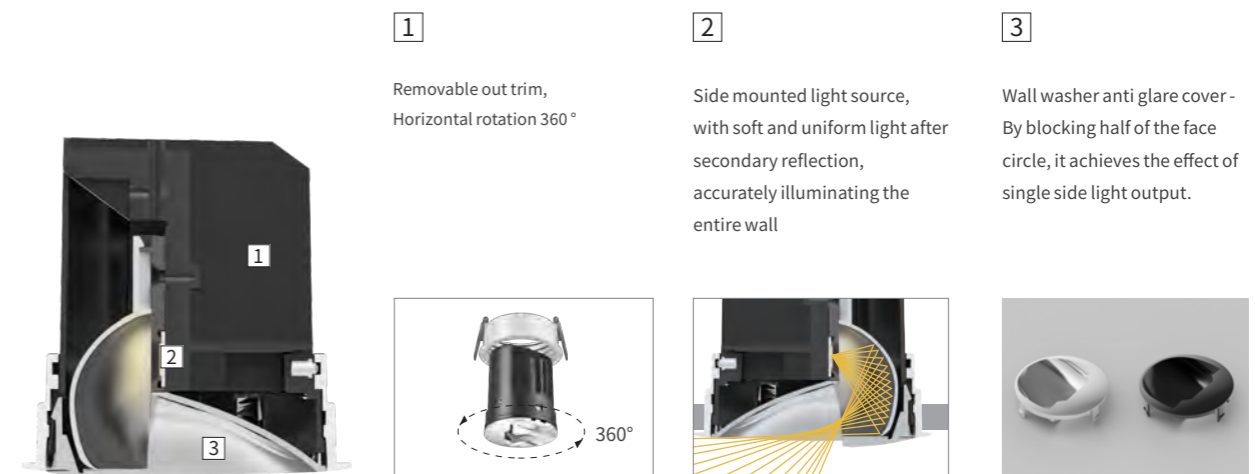
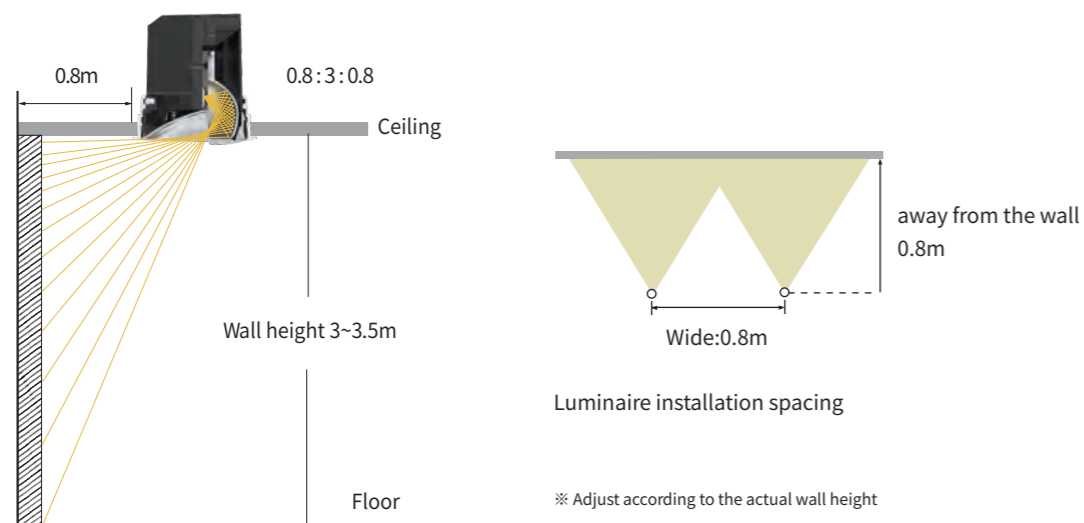



| Model Code | Power | LED Current | Lumen (±5%) | Beam angle | Input voltage         | CRI        | Dimming                  |
|------------|-------|-------------|-------------|------------|-----------------------|------------|--------------------------|
| DL06R55    | 7W    | 180mA       | 500 lm      | Wall Wash  | AC220-240V<br>50/60Hz | ≥90<br>≥97 | Triac<br>Dali<br>0/1-10V |

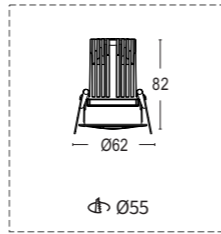

| Model Code | Power | LED Current | Lumen (±5%) | Beam angle | Input voltage         | CRI        | Dimming                  |
|------------|-------|-------------|-------------|------------|-----------------------|------------|--------------------------|
| DL06R75    | 12W   | 300mA       | 900 lm      | Wall Wash  | AC220-240V<br>50/60Hz | ≥90<br>≥97 | Triac<br>Dali<br>0/1-10V |

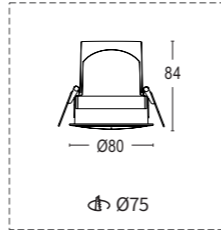

| Model Code | Power | LED Current | Lumen (±5%) | Beam angle | Input voltage         | CRI        | Dimming                  |
|------------|-------|-------------|-------------|------------|-----------------------|------------|--------------------------|
| DL06R95    | 25W   | 600mA       | 2000 lm     | Wall Wash  | AC220-240V<br>50/60Hz | ≥90<br>≥97 | Triac<br>Dali<br>0/1-10V |

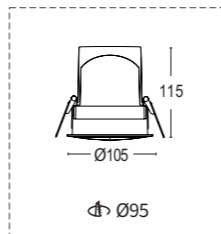

- **Swivel angle:**  
355°
- **CCT:**  
2700K/3000K/3500K/4000K/5700K
- **Finish:**  
White/Black
- **Light source:**  
COB LED  
Luminus/CREE/Bridgelux

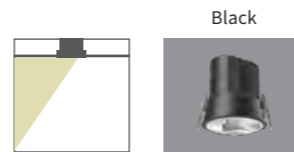

| Model Code | Power | LED Current | Lumen (±5%) | Beam angle | Input voltage         | CRI        | Dimming                  |
|------------|-------|-------------|-------------|------------|-----------------------|------------|--------------------------|
| DL06RT55   | 7W    | 180mA       | 500 lm      | Wall Wash  | AC220-240V<br>50/60Hz | ≥90<br>≥97 | Triac<br>Dali<br>0/1-10V |

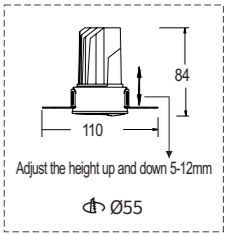

| Model Code | Power | LED Current | Lumen (±5%) | Beam angle | Input voltage         | CRI        | Dimming                  |
|------------|-------|-------------|-------------|------------|-----------------------|------------|--------------------------|
| DL06RT75   | 12W   | 300mA       | 900 lm      | Wall Wash  | AC220-240V<br>50/60Hz | ≥90<br>≥97 | Triac<br>Dali<br>0/1-10V |

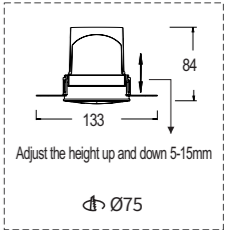

| Model Code | Power | LED Current | Lumen (±5%) | Beam angle | Input voltage         | CRI        | Dimming                  |
|------------|-------|-------------|-------------|------------|-----------------------|------------|--------------------------|
| DL06RT95   | 25W   | 600mA       | 2000 lm     | Wall Wash  | AC220-240V<br>50/60Hz | ≥90<br>≥97 | Triac<br>Dali<br>0/1-10V |

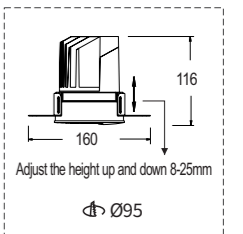

- **Swivel angle:**  
355°
- **CCT:**  
2700K/3000K/3500K/4000K/5700K
- **Finish:**  
White/Black
- **Light source:**  
COB LED  
Luminus/CREE/Bridgelux

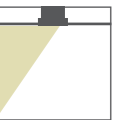
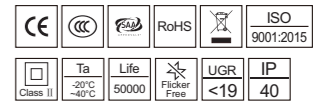



Single head

Double head

# NOVA

## TRACK WALL WASHER

THE NOVA SERIES IS ASYMMETRIC DOWNLIGHT THAT SPECIALLY DESIGNED FOR WALL WASHER EFFECT WITH A PERCISION DESIGNED WALL WASHER REFLECTOR CAN EFFECTIVELY REDUCE THE GLARE INDEX



Recessed



Surface mounted



Track mounted

Easy-swivel lighting  
direction for precise lighting control

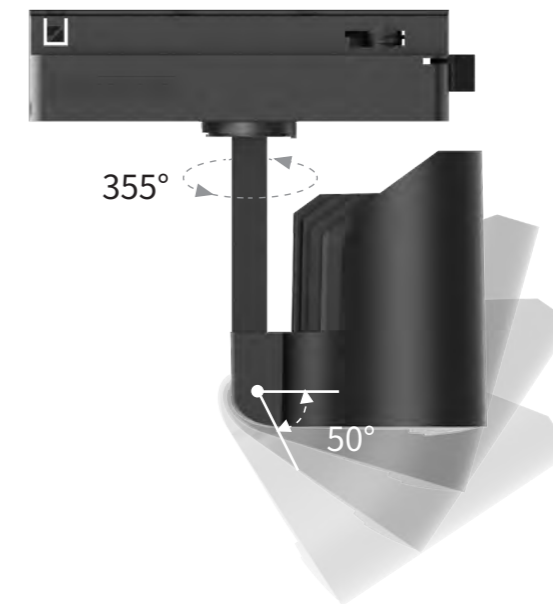

Available in 2 colors



Chrome black



Silver



| Model Code | Power | LED Current | Lumen (±5%) | Beam angle | Input voltage         | CRI        | Dimming                  |
|------------|-------|-------------|-------------|------------|-----------------------|------------|--------------------------|
| TL06R75    | 12W   | 300mA       | 850 lm      | Wall Wash  | AC220-240V<br>50/60Hz | ≥90<br>≥97 | Triac<br>Dali<br>0/1-10V |

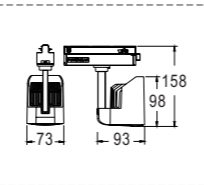

|         |     |       |         |           |                       |            |                          |
|---------|-----|-------|---------|-----------|-----------------------|------------|--------------------------|
| TL06R95 | 25W | 600mA | 1875 lm | Wall Wash | AC220-240V<br>50/60Hz | ≥90<br>≥97 | Triac<br>Dali<br>0/1-10V |
|---------|-----|-------|---------|-----------|-----------------------|------------|--------------------------|

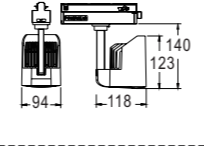

| Model Code | Power | LED Current | Lumen (±5%) | Beam angle | Input voltage         | CRI        | Dimming                  |
|------------|-------|-------------|-------------|------------|-----------------------|------------|--------------------------|
| DL06R75SM  | 12W   | 300mA       | 850 lm      | Wall Wash  | AC220-240V<br>50/60Hz | ≥90<br>≥97 | Triac<br>Dali<br>0/1-10V |

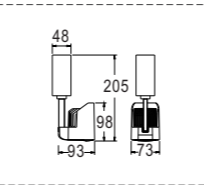

|           |     |       |         |           |                       |            |                          |
|-----------|-----|-------|---------|-----------|-----------------------|------------|--------------------------|
| DL06R95SM | 25W | 600mA | 1875 lm | Wall Wash | AC220-240V<br>50/60Hz | ≥90<br>≥97 | Triac<br>Dali<br>0/1-10V |
|-----------|-----|-------|---------|-----------|-----------------------|------------|--------------------------|

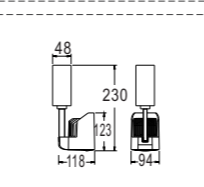

| Model Code | Power | LED Current | Lumen (±5%) | Beam angle | Input voltage         | CRI        | Dimming                  |
|------------|-------|-------------|-------------|------------|-----------------------|------------|--------------------------|
| DL06R75RM  | 12W   | 300mA       | 850 lm      | Wall Wash  | AC220-240V<br>50/60Hz | ≥90<br>≥97 | Triac<br>Dali<br>0/1-10V |

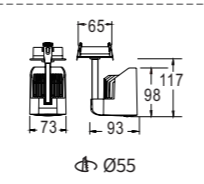

|           |     |       |         |           |                       |            |                          |
|-----------|-----|-------|---------|-----------|-----------------------|------------|--------------------------|
| DL06R95RM | 25W | 600mA | 1875 lm | Wall Wash | AC220-240V<br>50/60Hz | ≥90<br>≥97 | Triac<br>Dali<br>0/1-10V |
|-----------|-----|-------|---------|-----------|-----------------------|------------|--------------------------|

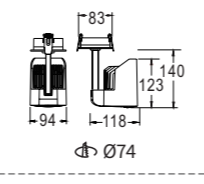

- **Swivel angle:**
- **CCT:**  
2700K/3000K/4000K/5700K
- **Finish:**  
White/Black
- **Mounting:**  
Track mounted ( 1/2/3 phase)
- **Light source:**  
COB LED  
Luminus/CREE/Bridgelux

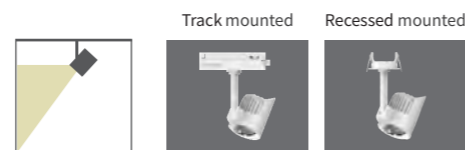

| Model Code | Power | LED Current | Lumen (±5%) | Beam angle | Input voltage         | CRI        | Dimming                  |
|------------|-------|-------------|-------------|------------|-----------------------|------------|--------------------------|
| TL06R75-2  | 2*12W | 300mA       | 1500 lm     | Wall Wash  | AC220-240V<br>50/60Hz | ≥90<br>≥97 | Triac<br>Dali<br>0/1-10V |

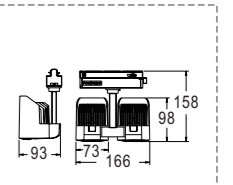

| Model Code  | Power | LED Current | Lumen (±5%) | Beam angle | Input voltage         | CRI        | Dimming                  |
|-------------|-------|-------------|-------------|------------|-----------------------|------------|--------------------------|
| DL06R75SM-2 | 2*12W | 300mA       | 1500 lm     | Wall Wash  | AC220-240V<br>50/60Hz | ≥90<br>≥97 | Triac<br>Dali<br>0/1-10V |

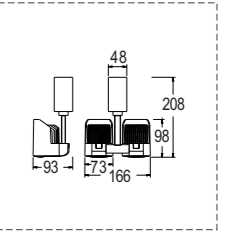

| Model Code  | Power | LED Current | Lumen (±5%) | Beam angle | Input voltage         | CRI        | Dimming                  |
|-------------|-------|-------------|-------------|------------|-----------------------|------------|--------------------------|
| DL06R75RM-2 | 2*12W | 300mA       | 1500 lm     | Wall Wash  | AC220-240V<br>50/60Hz | ≥90<br>≥97 | Triac<br>Dali<br>0/1-10V |

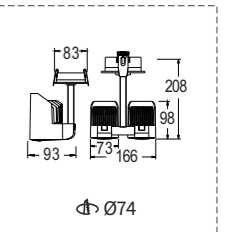

- **Swivel angle:**
- **CCT:**  
2700K/3000K/4000K/5700K
- **Finish:**  
White/Black
- **Mounting:**  
Track mounted ( 1/2/3 phase)
- **Light source:**  
COB LED  
Luminus/CREE/Bridgelux

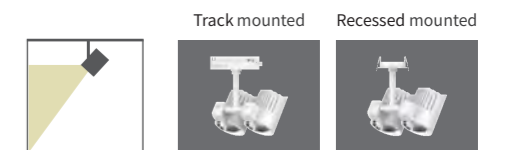
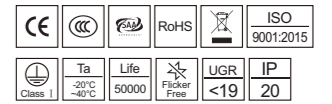

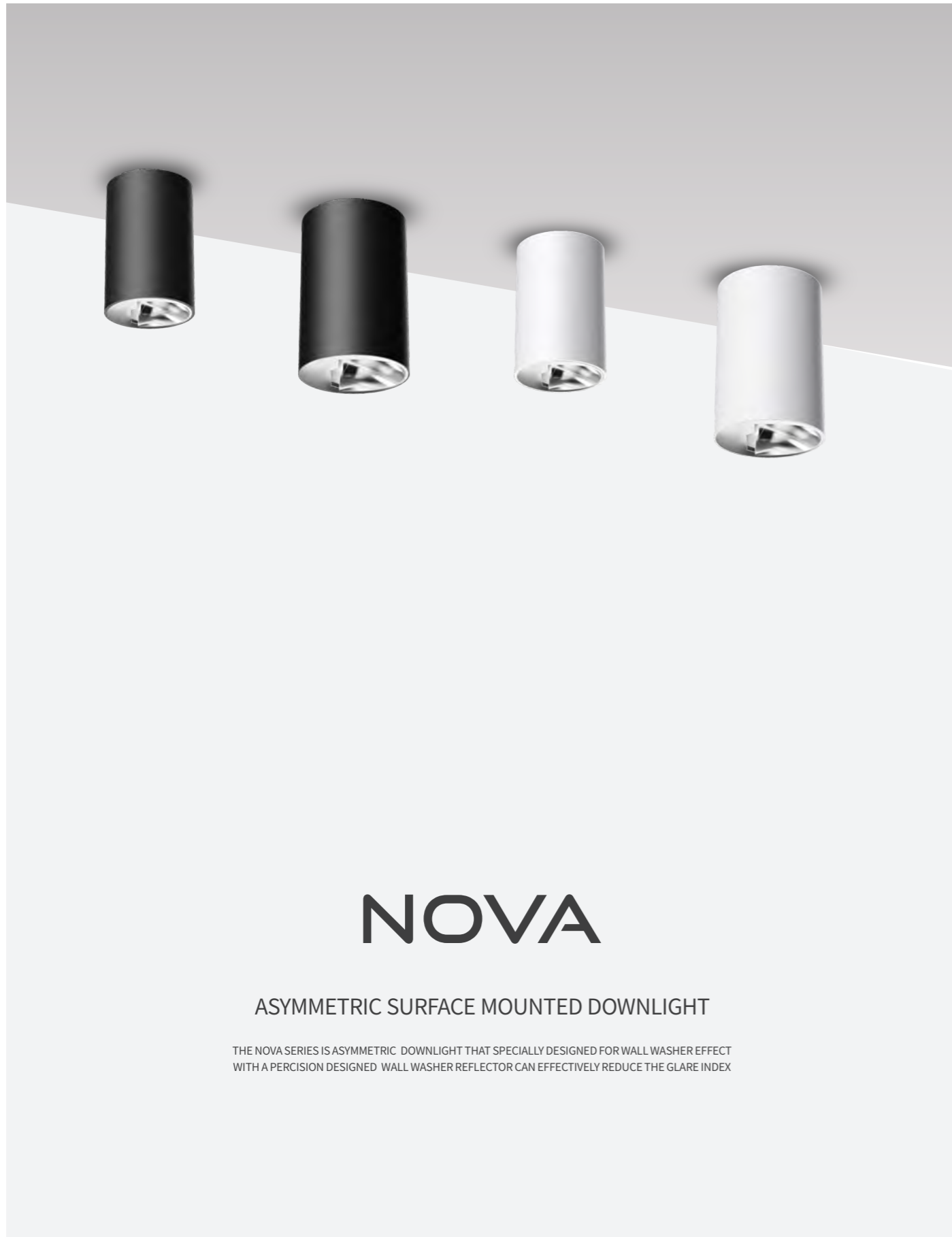

# NOVA

## ASYMMETRIC SURFACE MOUNTED DOWNLIGHT

THE NOVA SERIES IS ASYMMETRIC DOWNLIGHT THAT SPECIALLY DESIGNED FOR WALL WASHER EFFECT WITH A PRECISION DESIGNED WALL WASHER REFLECTOR CAN EFFECTIVELY REDUCE THE GLARE INDEX

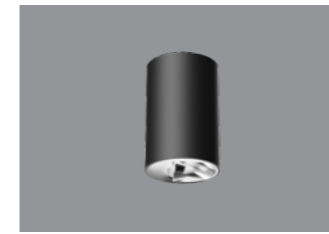

| Model Code | Power | LED Current | Lumen (±5%) | Beam angle | Input voltage         | CRI        | Dimming                  |
|------------|-------|-------------|-------------|------------|-----------------------|------------|--------------------------|
| DL06R75-MZ | 12W   | 300mA       | 900 lm      | Wall Wash  | AC220-240V<br>50/60Hz | ≥90<br>≥97 | Triac<br>Dali<br>0/1-10V |

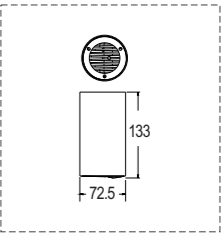

| Model Code | Power | LED Current | Lumen (±5%) | Beam angle | Input voltage         | CRI        | Dimming                  |
|------------|-------|-------------|-------------|------------|-----------------------|------------|--------------------------|
| DL06R95-MZ | 25W   | 600mA       | 2000 lm     | Wall Wash  | AC220-240V<br>50/60Hz | ≥90<br>≥97 | Triac<br>Dali<br>0/1-10V |

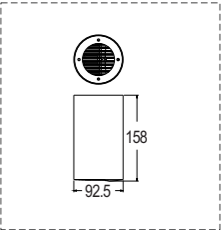

- **CCT:**  
2700K/3000K/3500K/4000K/5700K
- **Finish:**  
White/Black
- **Light source:**  
COB LED  
Luminus/CREE/Bridgelux

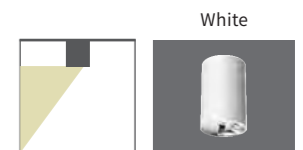
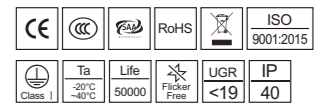

LED  
Scoop  
light



3

LED SCOOP LIGHT

ARES.....003

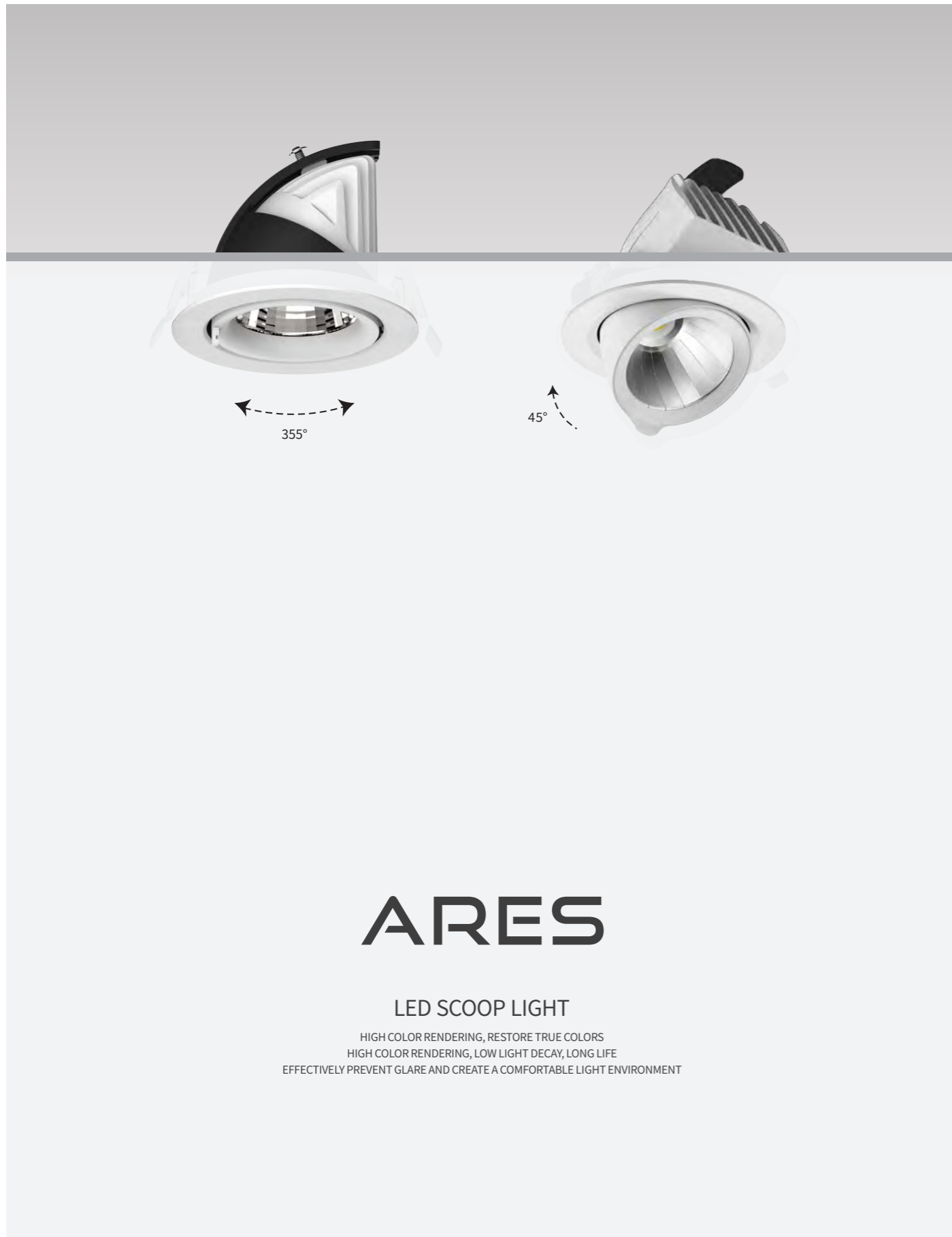

# ARES

## LED SCOOP LIGHT

HIGH COLOR RENDERING, RESTORE TRUE COLORS  
 HIGH COLOR RENDERING, LOW LIGHT DECAY, LONG LIFE  
 EFFECTIVELY PREVENT GLARE AND CREATE A COMFORTABLE LIGHT ENVIRONMENT



| Model Code | Power | LED Current | Lumen (±5%) | Beam angle      | Input voltage         | CRI        | Dimming                  |
|------------|-------|-------------|-------------|-----------------|-----------------------|------------|--------------------------|
| SL04R90    | 15W   | 350mA       | 1400 lm     | 15° 24° 36° 60° | AC220-240V<br>50/60Hz | ≥90<br>≥97 | Triac<br>Dali<br>0/1-10V |

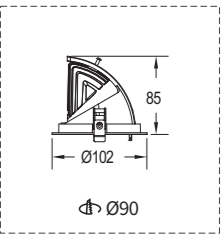

● Swivel angle:

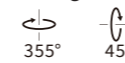

● CCT:

2700K/3000K/3500K/4000K/5700K

● Finish:

White/Black

● Light source:

COB LED  
Luminus/CREE/Bridgelux

| Model Code | Power | LED Current | Lumen (±5%) | Beam angle      | Input voltage         | CRI        | Dimming                  |
|------------|-------|-------------|-------------|-----------------|-----------------------|------------|--------------------------|
| SL04R125   | 25W   | 600mA       | 2500 lm     | 15° 24° 36° 60° | AC220-240V<br>50/60Hz | ≥90<br>≥97 | Triac<br>Dali<br>0/1-10V |

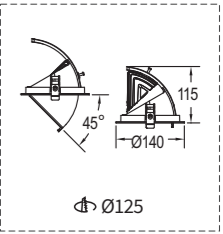

| Model Code | Power | LED Current | Lumen (±5%) | Beam angle      | Input voltage         | CRI        | Dimming                  |
|------------|-------|-------------|-------------|-----------------|-----------------------|------------|--------------------------|
| SL04R145   | 35W   | 850mA       | 3500 lm     | 15° 24° 36° 60° | AC220-240V<br>50/60Hz | ≥90<br>≥97 | Triac<br>Dali<br>0/1-10V |

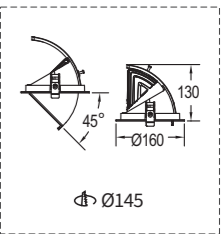

| Model Code | Power | LED Current | Lumen (±5%) | Beam angle      | Input voltage         | CRI        | Dimming                  |
|------------|-------|-------------|-------------|-----------------|-----------------------|------------|--------------------------|
| SL04R175   | 42W   | 1050mA      | 4200 lm     | 15° 24° 36° 60° | AC220-240V<br>50/60Hz | ≥90<br>≥97 | Triac<br>Dali<br>0/1-10V |

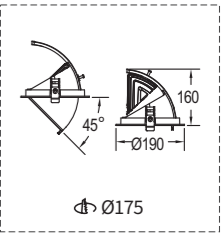

Reflector:



Regular PC reflector



| Model Code | Power | LED Current | Lumen (±5%) | Beam angle      | Input voltage         | CRI        | Dimming                  |
|------------|-------|-------------|-------------|-----------------|-----------------------|------------|--------------------------|
| SL04R90A   | 15W   | 350mA       | 1500 lm     | 15° 24° 36° 60° | AC220-240V<br>50/60Hz | ≥90<br>≥97 | Triac<br>Dali<br>0/1-10V |

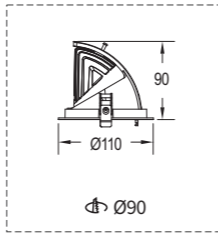

| Model Code | Power | LED Current | Lumen (±5%) | Beam angle      | Input voltage         | CRI        | Dimming                  |
|------------|-------|-------------|-------------|-----------------|-----------------------|------------|--------------------------|
| SL04R125A  | 25W   | 600mA       | 2500 lm     | 15° 24° 36° 60° | AC220-240V<br>50/60Hz | ≥90<br>≥97 | Triac<br>Dali<br>0/1-10V |

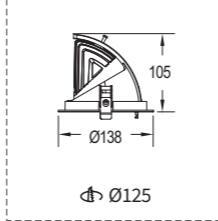

- **Swivel angle:**
- **CCT:**  
 2700K/3000K/3500K/4000K/5700K
- **Finish:**  
 White/Black
- **Light source:**  
 COB LED  
 Luminus/CREE/Bridgelux

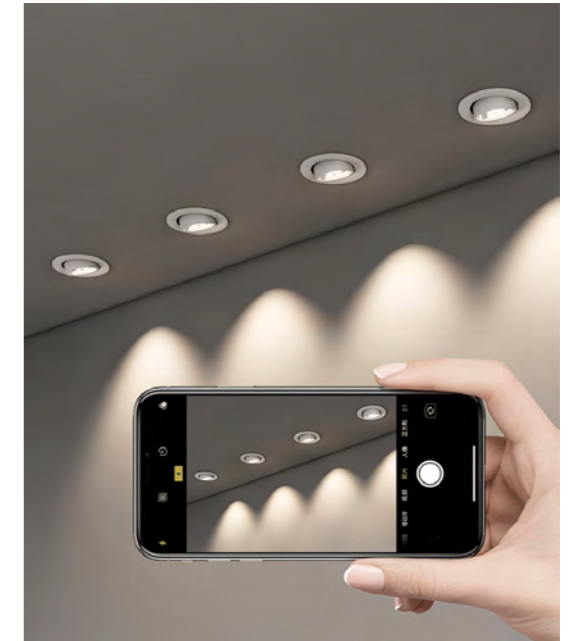

LED  
Pull out  
light



4

LED PULL OUT LIGHT

LOKI.....003

Stretch freely up&down

355°

60°

# LOKI

## LED PULL OUT LIGHT

THE LOKI SERIES CAN ROTATE 355° HORIZONTALY AND 60° VERTICALLY  
TRIMMED AND TRIMLESS DESIGN TO MEET DIFFERENT LIGHTING APPLICATIONS



| Model Code | Power | LED Current | Lumen (±5%) | Beam angle      | Input voltage         | CRI        | Dimming                  |
|------------|-------|-------------|-------------|-----------------|-----------------------|------------|--------------------------|
| PL03R55    | 6W    | 150mA       | 480 lm      | 15° 24° 38° 50° | AC220-240V<br>50/60Hz | ≥90<br>≥97 | Triac<br>Dali<br>0/1-10V |

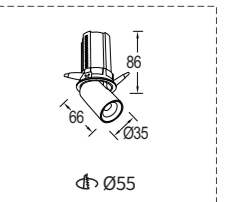

- **Swivel angle:**  
355° 60°
- **CCT:**  
2700K/3000K/3500K/4000K/5700K
- **Finish:**  
White/Black
- **Light source:**  
COB LED  
Luminus/CREE/Bridgelux

| Model Code | Power | LED Current | Lumen (±5%) | Beam angle      | Input voltage         | CRI        | Dimming                  |
|------------|-------|-------------|-------------|-----------------|-----------------------|------------|--------------------------|
| PL03R75    | 12W   | 300mA       | 1080 lm     | 15° 24° 38° 50° | AC220-240V<br>50/60Hz | ≥90<br>≥97 | Triac<br>Dali<br>0/1-10V |

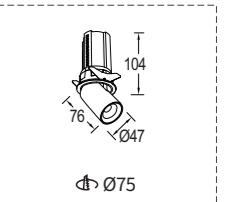

| Model Code | Power | LED Current | Lumen (±5%) | Beam angle      | Input voltage         | CRI        | Dimming                  |
|------------|-------|-------------|-------------|-----------------|-----------------------|------------|--------------------------|
| PL03R95    | 20W   | 500mA       | 1880 lm     | 15° 24° 38° 50° | AC220-240V<br>50/60Hz | ≥90<br>≥97 | Triac<br>Dali<br>0/1-10V |

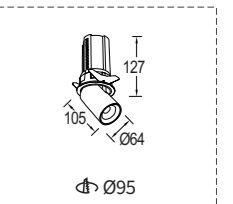

| Model Code | Power | LED Current | Lumen (±5%) | Beam angle      | Input voltage         | CRI        | Dimming                  |
|------------|-------|-------------|-------------|-----------------|-----------------------|------------|--------------------------|
| PL03RT55   | 6W    | 150mA       | 480 lm      | 15° 24° 38° 50° | AC220-240V<br>50/60Hz | ≥90<br>≥97 | Triac<br>Dali<br>0/1-10V |

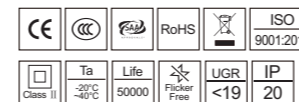
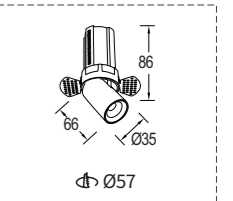

- **Swivel angle:**  
355° 60°
- **CCT:**  
2700K/3000K/3500K/4000K/5700K
- **Finish:**  
White/Black
- **Light source:**  
COB LED  
Luminus/CREE/Bridgelux

| Model Code | Power | LED Current | Lumen (±5%) | Beam angle      | Input voltage         | CRI        | Dimming                  |
|------------|-------|-------------|-------------|-----------------|-----------------------|------------|--------------------------|
| PL03RT75   | 12W   | 300mA       | 1080 lm     | 15° 24° 38° 50° | AC220-240V<br>50/60Hz | ≥90<br>≥97 | Triac<br>Dali<br>0/1-10V |

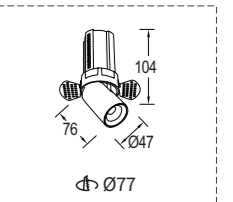

| Model Code | Power | LED Current | Lumen (±5%) | Beam angle      | Input voltage         | CRI        | Dimming                  |
|------------|-------|-------------|-------------|-----------------|-----------------------|------------|--------------------------|
| PL03RT95   | 20W   | 500mA       | 1880 lm     | 15° 24° 38° 50° | AC220-240V<br>50/60Hz | ≥90<br>≥97 | Triac<br>Dali<br>0/1-10V |

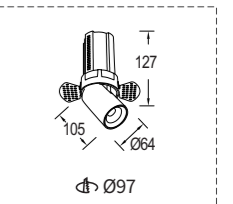



| Model Code | Power | LED Current | Lumen (±5%) | Beam angle  | Input voltage         | CRI        | Dimming                  |
|------------|-------|-------------|-------------|-------------|-----------------------|------------|--------------------------|
| PL03R120   | 25W   | 600mA       | 2375 lm     | 15° 24° 38° | AC220-240V<br>50/60Hz | ≥90<br>≥97 | Triac<br>Dali<br>0/1-10V |

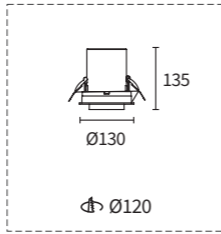

| Model Code | Power | LED Current | Lumen (±5%) | Beam angle  | Input voltage         | CRI        | Dimming                  |
|------------|-------|-------------|-------------|-------------|-----------------------|------------|--------------------------|
| PL03R140   | 35W   | 850mA       | 3325 lm     | 15° 24° 38° | AC220-240V<br>50/60Hz | ≥90<br>≥97 | Triac<br>Dali<br>0/1-10V |

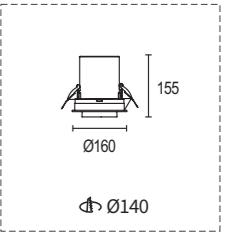

| Model Code | Power | LED Current | Lumen (±5%) | Beam angle  | Input voltage         | CRI        | Dimming                  |
|------------|-------|-------------|-------------|-------------|-----------------------|------------|--------------------------|
| PL03S120   | 25W   | 600mA       | 2375 lm     | 15° 24° 38° | AC220-240V<br>50/60Hz | ≥90<br>≥97 | Triac<br>Dali<br>0/1-10V |

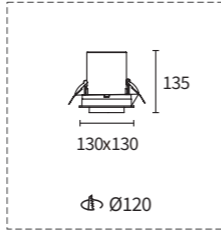

| Model Code | Power | LED Current | Lumen (±5%) | Beam angle  | Input voltage         | CRI        | Dimming                  |
|------------|-------|-------------|-------------|-------------|-----------------------|------------|--------------------------|
| PL03S140   | 35W   | 850mA       | 3325 lm     | 15° 24° 38° | AC220-240V<br>50/60Hz | ≥90<br>≥97 | Triac<br>Dali<br>0/1-10V |

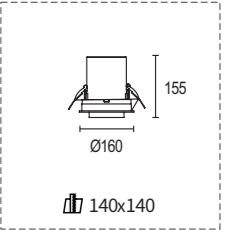

| Model Code | Power | LED Current | Lumen (±5%) | Beam angle  | Input voltage         | CRI        | Dimming                  |
|------------|-------|-------------|-------------|-------------|-----------------------|------------|--------------------------|
| PL03S120-2 | 2x25W | 600mA       | 4750 lm     | 15° 24° 38° | AC220-240V<br>50/60Hz | ≥90<br>≥97 | Triac<br>Dali<br>0/1-10V |

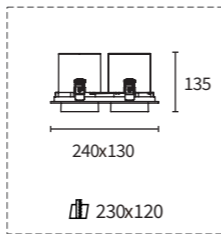

| Model Code | Power | LED Current | Lumen (±5%) | Beam angle  | Input voltage         | CRI        | Dimming                  |
|------------|-------|-------------|-------------|-------------|-----------------------|------------|--------------------------|
| PL03S140-2 | 2x35W | 850mA       | 7025 lm     | 15° 24° 38° | AC220-240V<br>50/60Hz | ≥90<br>≥97 | Triac<br>Dali<br>0/1-10V |

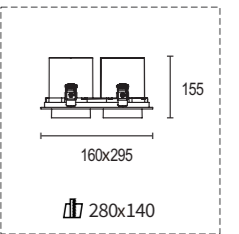

| Model Code | Power | LED Current | Lumen (±5%) | Beam angle  | Input voltage         | CRI        | Dimming                  |
|------------|-------|-------------|-------------|-------------|-----------------------|------------|--------------------------|
| PL03S120-3 | 3x25W | 600mA       | 7025 lm     | 15° 24° 38° | AC220-240V<br>50/60Hz | ≥90<br>≥97 | Triac<br>Dali<br>0/1-10V |

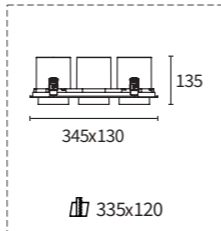

- **Swivel angle:**  
355° 60°
- **CCT:**  
2700K/3000K/3500K/4000K/5700K
- **Finish:**  
White/Black
- **Light source:**  
COB LED  
Luminus/CREE/Bridgelux



- **Swivel angle:**  
355° 60°
- **CCT:**  
2700K/3000K/3500K/4000K/5700K
- **Finish:**  
White/Black
- **Light source:**  
COB LED  
Luminus/CREE/Bridgelux



| Model Code | Power | LED Current | Lumen (±5%) | Beam angle      | Input voltage         | CRI        | Dimming                  |
|------------|-------|-------------|-------------|-----------------|-----------------------|------------|--------------------------|
| SL06R60    | 8W    | 200mA       | 650 lm      | 15° 24° 38° 60° | AC220-240V<br>50/60Hz | ≥90<br>≥97 | Triac<br>Dali<br>0/1-10V |

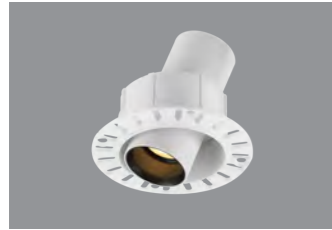
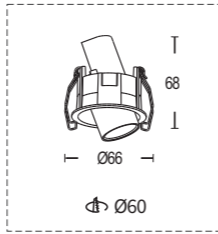

| Model Code | Power | LED Current | Lumen (±5%) | Beam angle      | Input voltage         | CRI        | Dimming                  |
|------------|-------|-------------|-------------|-----------------|-----------------------|------------|--------------------------|
| SL06RT60   | 8W    | 200mA       | 650 lm      | 15° 24° 38° 60° | AC220-240V<br>50/60Hz | ≥90<br>≥97 | Triac<br>Dali<br>0/1-10V |

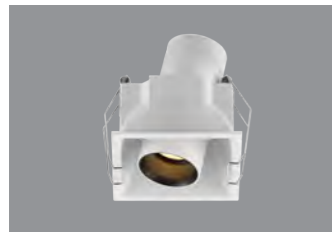
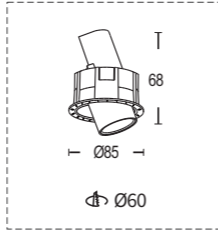

| Model Code | Power | LED Current | Lumen (±5%) | Beam angle      | Input voltage         | CRI        | Dimming                  |
|------------|-------|-------------|-------------|-----------------|-----------------------|------------|--------------------------|
| SL06S60    | 8W    | 200mA       | 650 lm      | 15° 24° 38° 60° | AC220-240V<br>50/60Hz | ≥90<br>≥97 | Triac<br>Dali<br>0/1-10V |

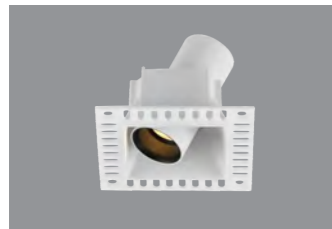
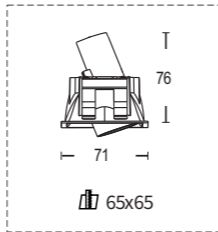

| Model Code | Power | LED Current | Lumen (±5%) | Beam angle      | Input voltage         | CRI        | Dimming                  |
|------------|-------|-------------|-------------|-----------------|-----------------------|------------|--------------------------|
| SL06ST60   | 8W    | 200mA       | 650 lm      | 15° 24° 38° 60° | AC220-240V<br>50/60Hz | ≥90<br>≥97 | Triac<br>Dali<br>0/1-10V |

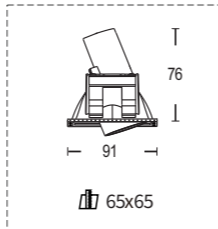

This adjustable spotlight features 360° in swivel angle, deep anti-glare snoot with an ultra-narrow trim, a flexible ball-joint structure for easy disassembly

- **Swivel angle:**
- **CCT:**  
2700K/3000K/3500K/4000K/5700K
- **Finish:**  
White/Black
- **Light source:**  
COB LED  
Luminus/CREE/Bridgelux



# Surface Mounted downlight



# 5

Surface mounted downlight

UNO.....003  
BOX.....003



# UNO

## IP65 WATERPROOF SURFACE MOUNTED DOWNLIGHT

THE UNO SERIES OF SURFACE MOUNTED DOWNLIGHT ADOPTS HIGH LUMEN LED CHIP AND PC LENS WHICH MAKE SURE THE HIGH LUMINOUS, DIE-CASITING ALUMINUM HOUSING PROVIDES EXCELLENT HEAT DISSIPATION. THE INSTALLATION IS VERY EASY, THE FRONT FACE IS WITH IP54 PROTECTION LEVEL.

## WATERPROOF SURFACE MOUNTED DOWNLIGHT

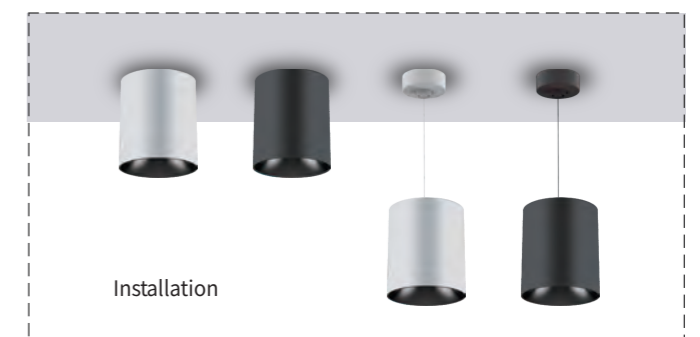



| Model Code | Power | LED Current | Lumen (±5%) | Beam angle  | Input voltage         | CRI        | Dimming                  |
|------------|-------|-------------|-------------|-------------|-----------------------|------------|--------------------------|
| DL01R250   | 10W   | 250mA       | 750 lm      | 20° 40° 60° | AC220-240V<br>50/60Hz | ≥90<br>≥97 | Triac<br>Dali<br>0/1-10V |

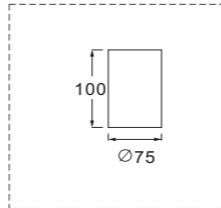

- **CCT:**  
2700K/3000K/3500K/4000K/5700K
- **Finish:**  
White/Black
- **Light source:**  
COB LED  
Luminus/CREE/Bridgelux

| Model Code | Power | LED Current | Lumen (±5%) | Beam angle  | Input voltage         | CRI        | Dimming                  |
|------------|-------|-------------|-------------|-------------|-----------------------|------------|--------------------------|
| DL01R300   | 15W   | 350mA       | 1200 lm     | 20° 40° 60° | AC220-240V<br>50/60Hz | ≥90<br>≥97 | Triac<br>Dali<br>0/1-10V |

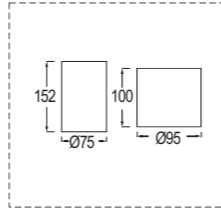

| Model Code | Power | LED Current | Lumen (±5%) | Beam angle  | Input voltage         | CRI        | Dimming                  |
|------------|-------|-------------|-------------|-------------|-----------------------|------------|--------------------------|
| DL01R400   | 20W   | 600mA       | 1800 lm     | 20° 40° 60° | AC220-240V<br>50/60Hz | ≥90<br>≥97 | Triac<br>Dali<br>0/1-10V |

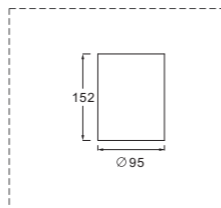

| Model Code | Power | LED Current | Lumen (±5%) | Beam angle  | Input voltage         | CRI        | Dimming                  |
|------------|-------|-------------|-------------|-------------|-----------------------|------------|--------------------------|
| DL01R500   | 30W   | 700mA       | 2850 lm     | 20° 40° 60° | AC220-240V<br>50/60Hz | ≥90<br>≥97 | Triac<br>Dali<br>0/1-10V |

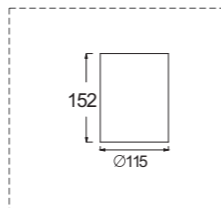

| Model Code | Power | LED Current | Lumen (±5%) | Beam angle  | Input voltage         | CRI        | Dimming                  |
|------------|-------|-------------|-------------|-------------|-----------------------|------------|--------------------------|
| DL01R600   | 50W   | 1200mA      | 5000 lm     | 20° 40° 60° | AC220-240V<br>50/60Hz | ≥90<br>≥97 | Triac<br>Dali<br>0/1-10V |

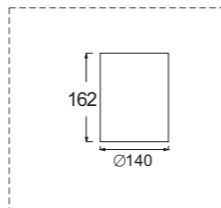

| Model Code | Power | LED Current | Lumen (±5%) | Beam angle  | Input voltage         | CRI        | Dimming                  |
|------------|-------|-------------|-------------|-------------|-----------------------|------------|--------------------------|
| DL01R800   | 60W   | 1400mA      | 6000 lm     | 20° 40° 60° | AC220-240V<br>50/60Hz | ≥90<br>≥97 | Triac<br>Dali<br>0/1-10V |

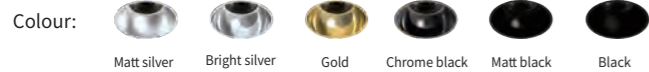
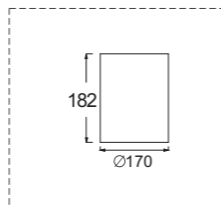

Pendant Installation

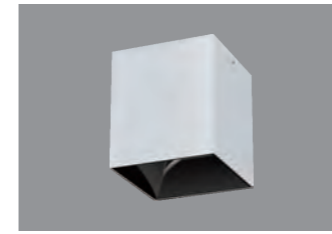

| Model Code | Power | LED Current | Lumen (±5%) | Beam angle      | Input voltage         | CRI        | Dimming                  |
|------------|-------|-------------|-------------|-----------------|-----------------------|------------|--------------------------|
| DL01S250   | 15W   | 350mA       | 1200 lm     | 15° 24° 36° 55° | AC220-240V<br>50/60Hz | ≥90<br>≥97 | Triac<br>Dali<br>0/1-10V |

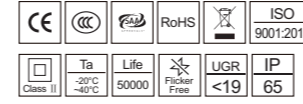
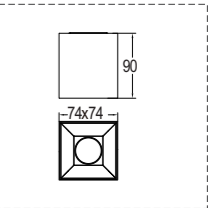

- **CCT:**  
2700K/3000K/3500K/4000K/5700K
- **Finish:**  
White/Black
- **Light source:**  
COB LED  
Luminus/CREE/Bridgelux

| Model Code | Power | LED Current | Lumen (±5%) | Beam angle      | Input voltage         | CRI        | Dimming                  |
|------------|-------|-------------|-------------|-----------------|-----------------------|------------|--------------------------|
| DL01S300   | 25W   | 600mA       | 2250 lm     | 15° 24° 36° 55° | AC220-240V<br>50/60Hz | ≥90<br>≥97 | Triac<br>Dali<br>0/1-10V |

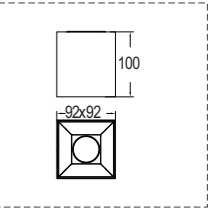

| Model Code | Power | LED Current | Lumen (±5%) | Beam angle      | Input voltage         | CRI        | Dimming                  |
|------------|-------|-------------|-------------|-----------------|-----------------------|------------|--------------------------|
| DL01S500   | 35W   | 850mA       | 3325 lm     | 15° 24° 36° 55° | AC220-240V<br>50/60Hz | ≥90<br>≥97 | Triac<br>Dali<br>0/1-10V |

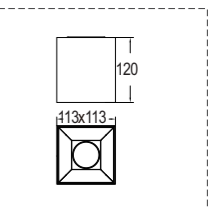

| Model Code | Power | LED Current | Lumen (±5%) | Beam angle      | Input voltage         | CRI        | Dimming                  |
|------------|-------|-------------|-------------|-----------------|-----------------------|------------|--------------------------|
| DL01S600   | 45W   | 1100mA      | 4500 lm     | 15° 24° 36° 55° | AC220-240V<br>50/60Hz | ≥90<br>≥97 | Triac<br>Dali<br>0/1-10V |

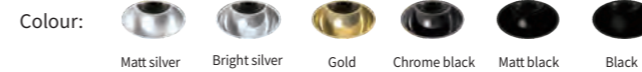
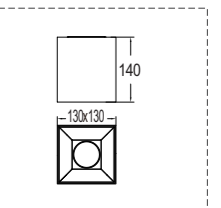

Pendant Installation





| Model Code | Power | LED Current | Lumen (±5%) | Beam angle | Input voltage         | CRI        | Dimming                  |
|------------|-------|-------------|-------------|------------|-----------------------|------------|--------------------------|
| DL01R25T   | 10W   | 250mA       | 850 lm      | 40° 60°    | AC220-240V<br>50/60Hz | ≥90<br>≥97 | Triac<br>Dali<br>0/1-10V |

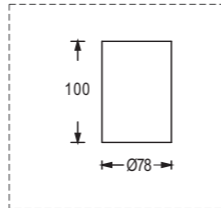

- **CCT:**  
2700K/3000K/3500K/4000K/5700K
- **Finish:**  
White/Black/Grey
- **Light source:**  
COB LED  
Luminus/CREE/Bridgelux

| Model Code | Power | LED Current | Lumen (±5%) | Beam angle | Input voltage         | CRI        | Dimming                  |
|------------|-------|-------------|-------------|------------|-----------------------|------------|--------------------------|
| DL01R35T   | 20W   | 500mA       | 1800 lm     | 40° 60°    | AC220-240V<br>50/60Hz | ≥90<br>≥97 | Triac<br>Dali<br>0/1-10V |

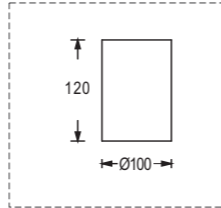

| Model Code | Power | LED Current | Lumen (±5%) | Beam angle | Input voltage         | CRI        | Dimming                  |
|------------|-------|-------------|-------------|------------|-----------------------|------------|--------------------------|
| DL01R40T   | 30W   | 700mA       | 2850 lm     | 40° 60°    | AC220-240V<br>50/60Hz | ≥90<br>≥97 | Triac<br>Dali<br>0/1-10V |

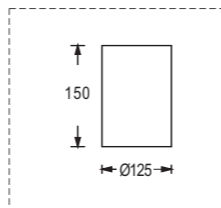

| Model Code | Power | LED Current | Lumen (±5%) | Beam angle | Input voltage         | CRI        | Dimming                  |
|------------|-------|-------------|-------------|------------|-----------------------|------------|--------------------------|
| DL01R60T   | 40W   | 950mA       | 3950 lm     | 40° 60°    | AC220-240V<br>50/60Hz | ≥90<br>≥97 | Triac<br>Dali<br>0/1-10V |

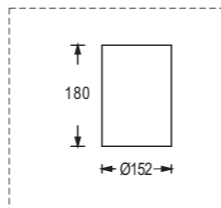

Pendant Installation

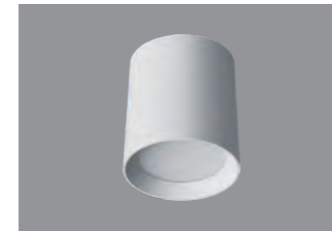

| Model Code | Power | LED Current | Lumen (±5%) | Beam angle | Input voltage         | CRI        | Dimming                  |
|------------|-------|-------------|-------------|------------|-----------------------|------------|--------------------------|
| DL01R25F   | 10W   | 250mA       | 850 lm      | 90°        | AC220-240V<br>50/60Hz | ≥90<br>≥97 | Triac<br>Dali<br>0/1-10V |

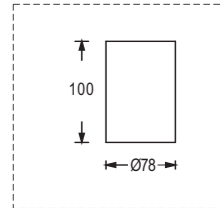

- **CCT:**  
2700K/3000K/3500K/4000K/5700K
- **Finish:**  
White/Black/Grey
- **Light source:**  
COB LED  
Luminus/CREE/Bridgelux

| Model Code | Power | LED Current | Lumen (±5%) | Beam angle | Input voltage         | CRI        | Dimming                  |
|------------|-------|-------------|-------------|------------|-----------------------|------------|--------------------------|
| DL01R35F   | 20W   | 500mA       | 1800 lm     | 90°        | AC220-240V<br>50/60Hz | ≥90<br>≥97 | Triac<br>Dali<br>0/1-10V |

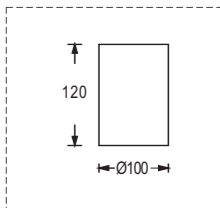

| Model Code | Power | LED Current | Lumen (±5%) | Beam angle | Input voltage         | CRI        | Dimming                  |
|------------|-------|-------------|-------------|------------|-----------------------|------------|--------------------------|
| DL01R40F   | 30W   | 700mA       | 2850 lm     | 90°        | AC220-240V<br>50/60Hz | ≥90<br>≥97 | Triac<br>Dali<br>0/1-10V |

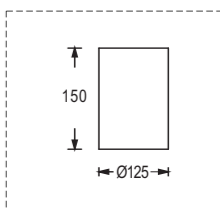

| Model Code | Power | LED Current | Lumen (±5%) | Beam angle | Input voltage         | CRI        | Dimming                  |
|------------|-------|-------------|-------------|------------|-----------------------|------------|--------------------------|
| DL01R60F   | 40W   | 950mA       | 3950 lm     | 90°        | AC220-240V<br>50/60Hz | ≥90<br>≥97 | Triac<br>Dali<br>0/1-10V |

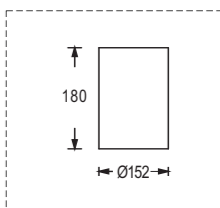

Pendant Installation



| Model Code | Power | LED Current | Lumen (±5%) | Beam angle | Input voltage         | CRI        | Dimming                  |
|------------|-------|-------------|-------------|------------|-----------------------|------------|--------------------------|
| DL01R150F  | 30W   | 700mA       | 2800 lm     | 120°       | AC220-240V<br>50/60Hz | ≥80<br>≥90 | Triac<br>Dali<br>0/1-10V |

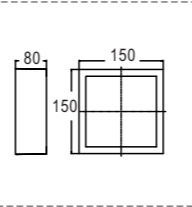

- **CCT:**  
3000K/4000K/6000K
- **Finish:**  
White/Black
- **Driver:**  
Eaglerise/Philips/Tridonic
- **Light source:**  
SMD LED

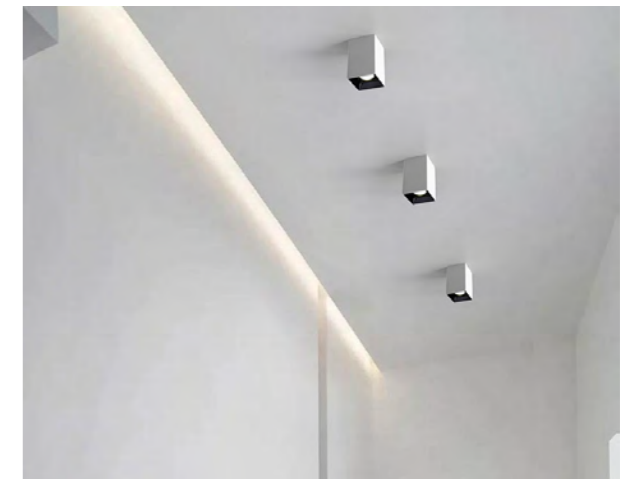
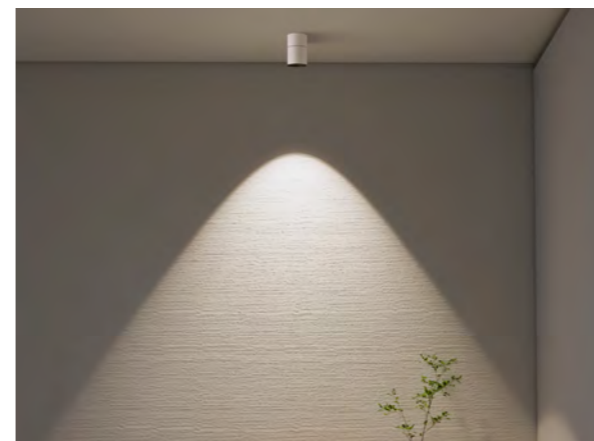
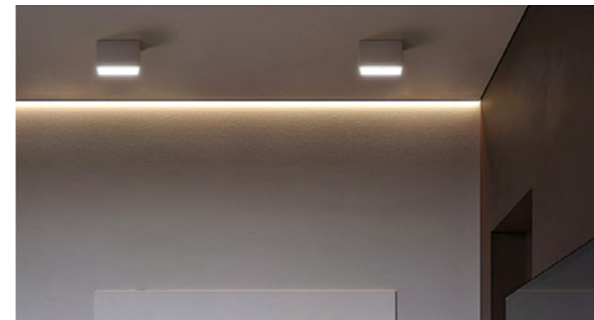
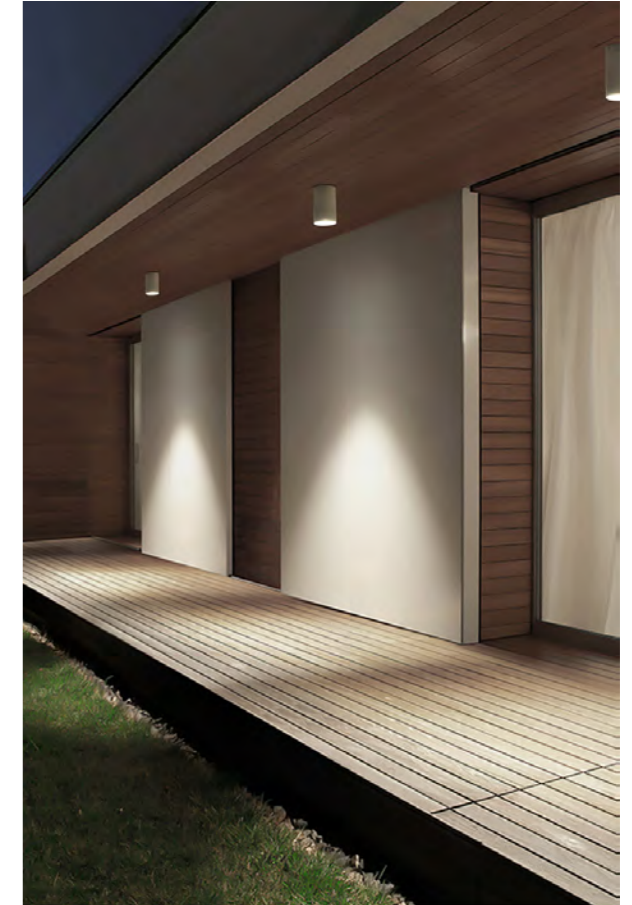



# BOX

## SURFACE MOUNTED DOWNLIGHT

ADJUSTABLE HEAD FOR DIFFERENT DIRECTIONS LIGHTING  
 HIGH COLOR RENDERING LOW LIGHT DECAY, LONG LIFE  
 EFFECTIVELY PREVENT GLARE AND CREATE A COMFORTABLE LIGHT ENVIRONMENT



Surface mounted



Track mounted



| Model Code | Power | LED Current | Lumen (±5%) | Beam angle  | Input voltage         | CRI        | Dimming                  |
|------------|-------|-------------|-------------|-------------|-----------------------|------------|--------------------------|
| TB001      | 12W   | 300mA       | 850 lm      | 10° 20° 30° | AC220-240V<br>50/60Hz | ≥90<br>≥97 | Triac<br>Dali<br>0/1-10V |

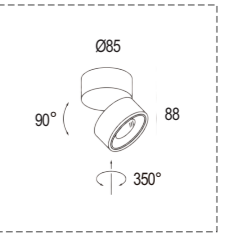

| Model Code | Power | LED Current | Lumen (±5%) | Beam angle  | Input voltage         | CRI        | Dimming                  |
|------------|-------|-------------|-------------|-------------|-----------------------|------------|--------------------------|
| TB001L     | 12W   | 300mA       | 850 lm      | 10° 20° 30° | AC220-240V<br>50/60Hz | ≥90<br>≥97 | Triac<br>Dali<br>0/1-10V |

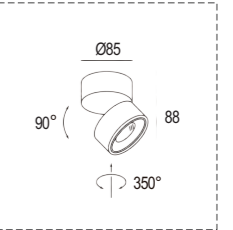

| Model Code | Power | LED Current | Lumen (±5%) | Beam angle      | Input voltage         | CRI        | Dimming                  |
|------------|-------|-------------|-------------|-----------------|-----------------------|------------|--------------------------|
| TC200      | 12W   | 300mA       | 850 lm      | 15° 25° 35° 50° | AC220-240V<br>50/60Hz | ≥90<br>≥97 | Triac<br>Dali<br>0/1-10V |

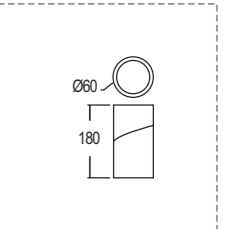

| Model Code | Power | LED Current | Lumen (±5%) | Beam angle      | Input voltage         | CRI        | Dimming                  |
|------------|-------|-------------|-------------|-----------------|-----------------------|------------|--------------------------|
| TC201      | 20W   | 500mA       | 1660 lm     | 15° 25° 35° 50° | AC220-240V<br>50/60Hz | ≥90<br>≥97 | Triac<br>Dali<br>0/1-10V |

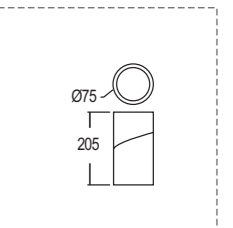

● Swivel angle:



● CCT:

2700K/3000K/3500K/4000K/5700K

● Finish:

White/Black

● Light source:

COB LED  
 Luminus/CREE/Bridgelux



White

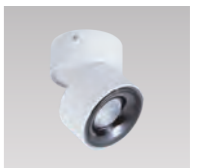

LED  
Grille  
light



6

LED GRILLE LIGHT

VEXA.....003  
BLED.....003



# VEXA

## LED GRILLE LIGHT

THE VEXA SURFACE MOUNTED LINEAR LIGHT  
ADOPTING HD LENS AND SMD CHIP  
ADC12 HEATSINK PROVIDE SUPER GREAT HEAT DISSAPTION



| Model Code | Power | LED Current | Lumen (±5%) | Beam angle  | Input voltage         | CRI        | Dimming                  |
|------------|-------|-------------|-------------|-------------|-----------------------|------------|--------------------------|
| DL052C-3   | 6W    | 350mA       | 300 lm      | 15° 24° 38° | AC220-240V<br>50/60Hz | ≥90<br>≥97 | Triac<br>Dali<br>0/1-10V |

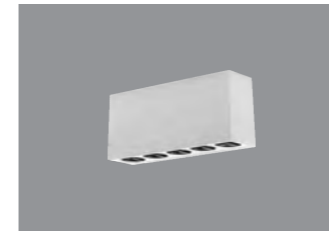
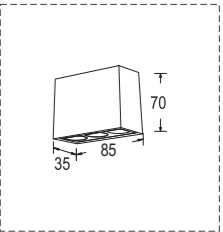

| Model Code | Power | LED Current | Lumen (±5%) | Beam angle  | Input voltage         | CRI        | Dimming                  |
|------------|-------|-------------|-------------|-------------|-----------------------|------------|--------------------------|
| DL052C-5   | 10W   | 500mA       | 700lm       | 15° 24° 38° | AC220-240V<br>50/60Hz | ≥90<br>≥97 | Triac<br>Dali<br>0/1-10V |

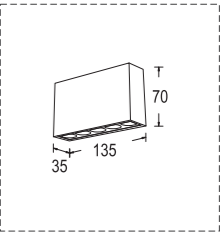

| Model Code | Power | LED Current | Lumen (±5%) | Beam angle  | Input voltage         | CRI        | Dimming                  |
|------------|-------|-------------|-------------|-------------|-----------------------|------------|--------------------------|
| DL052C-10  | 20W   | 550mA       | 1350 lm     | 15° 24° 38° | AC220-240V<br>50/60Hz | ≥90<br>≥97 | Triac<br>Dali<br>0/1-10V |

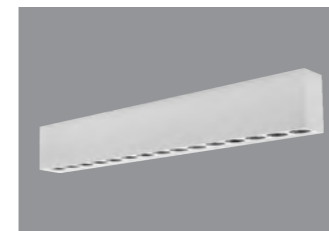
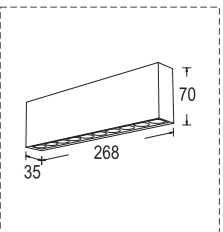

| Model Code | Power | LED Current | Lumen (±5%) | Beam angle  | Input voltage         | CRI        | Dimming                  |
|------------|-------|-------------|-------------|-------------|-----------------------|------------|--------------------------|
| DL052C-15  | 30W   | 700mA       | 2250 lm     | 15° 24° 38° | AC220-240V<br>50/60Hz | ≥90<br>≥97 | Triac<br>Dali<br>0/1-10V |

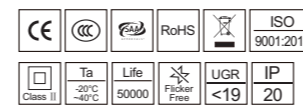
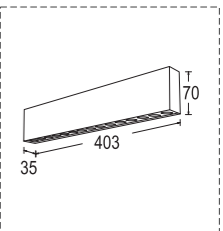

- **CCT:**  
2700K/3000K/3500K/4000K/5700K
- **Finish:**  
White/Black
- **Light source:**  
SMD LED  
OSRAM/Sanan/Bridgelux





| Model Code | Power | LED Current | Lumen (±5%) | Beam angle | Input voltage         | CRI        | Dimming                  |
|------------|-------|-------------|-------------|------------|-----------------------|------------|--------------------------|
| LT030-3B   | 4.5W  | 350mA       | 300 lm      | 30°        | AC220-240V<br>50/60Hz | ≥90<br>≥97 | Triac<br>Dali<br>0/1-10V |

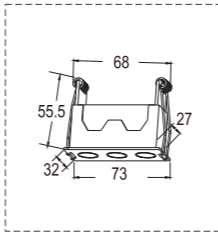

| Model Code | Power | LED Current | Lumen (±5%) | Beam angle | Input voltage         | CRI        | Dimming                  |
|------------|-------|-------------|-------------|------------|-----------------------|------------|--------------------------|
| LT030-6B   | 9W    | 500mA       | 700lm       | 30°        | AC220-240V<br>50/60Hz | ≥90<br>≥97 | Triac<br>Dali<br>0/1-10V |

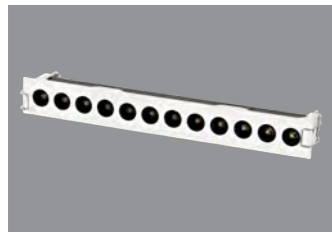
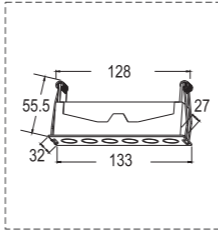

| Model Code | Power | LED Current | Lumen (±5%) | Beam angle | Input voltage         | CRI        | Dimming                  |
|------------|-------|-------------|-------------|------------|-----------------------|------------|--------------------------|
| LT030-12B  | 18W   | 450mA       | 1350 lm     | 30°        | AC220-240V<br>50/60Hz | ≥90<br>≥97 | Triac<br>Dali<br>0/1-10V |

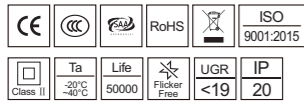
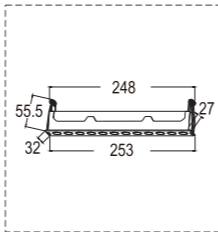

- **CCT:**  
2700K/3000K/3500K/4000K/5700K
- **Finish:**  
White/Black
- **Light source:**  
SMD LED  
OSRAM/Sanan/Bridgelux





| Model Code | Power | LED Current | Lumen (±5%) | Beam angle  | Input voltage         | CRI        | Dimming                  |
|------------|-------|-------------|-------------|-------------|-----------------------|------------|--------------------------|
| GL0137     | 3W    | 700mA       | 150 lm      | 15° 30° 45° | AC220-240V<br>50/60Hz | ≥90<br>≥97 | Triac<br>Dali<br>0/1-10V |

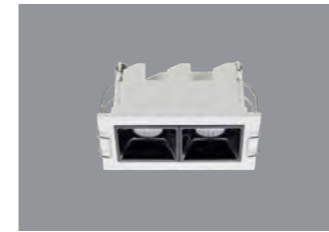
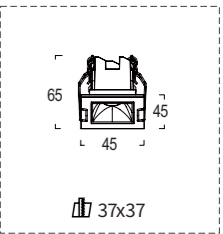

| Model Code | Power | LED Current | Lumen (±5%) | Beam angle  | Input voltage         | CRI        | Dimming                  |
|------------|-------|-------------|-------------|-------------|-----------------------|------------|--------------------------|
| GL0237     | 6W    | 700mA       | 300lm       | 15° 30° 45° | AC220-240V<br>50/60Hz | ≥90<br>≥97 | Triac<br>Dali<br>0/1-10V |

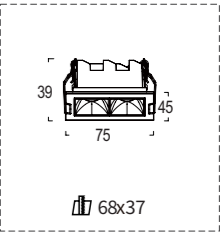

| Model Code | Power | LED Current | Lumen (±5%) | Beam angle  | Input voltage         | CRI        | Dimming                  |
|------------|-------|-------------|-------------|-------------|-----------------------|------------|--------------------------|
| GL0537     | 12W   | 700mA       | 600 lm      | 15° 30° 45° | AC220-240V<br>50/60Hz | ≥90<br>≥97 | Triac<br>Dali<br>0/1-10V |

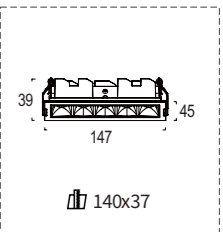

| Model Code | Power | LED Current | Lumen (±5%) | Beam angle  | Input voltage         | CRI        | Dimming                  |
|------------|-------|-------------|-------------|-------------|-----------------------|------------|--------------------------|
| GL1037     | 22W   | 700mA       | 1100 lm     | 15° 30° 45° | AC220-240V<br>50/60Hz | ≥90<br>≥97 | Triac<br>Dali<br>0/1-10V |

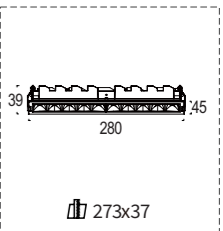

| Model Code | Power | LED Current | Lumen (±5%) | Beam angle  | Input voltage         | CRI        | Dimming                  |
|------------|-------|-------------|-------------|-------------|-----------------------|------------|--------------------------|
| GL1537     | 35W   | 700mA       | 1600 lm     | 15° 30° 45° | AC220-240V<br>50/60Hz | ≥90<br>≥97 | Triac<br>Dali<br>0/1-10V |

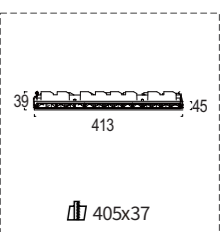

- **CCT:**  
2700K/3000K/3500K/4000K/5700K
- **Finish:**  
White/Black/Grey
- **Light source:**  
COB LED  
Luminus/CREE/Bridgelux

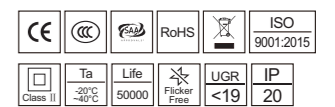

LED  
Down  
light



7

LED DOWN LIGHT

WILL.....003  
SOVA.....003  
HALO.....003

DORIS.....003  
LITA.....003  
CAVO.....003

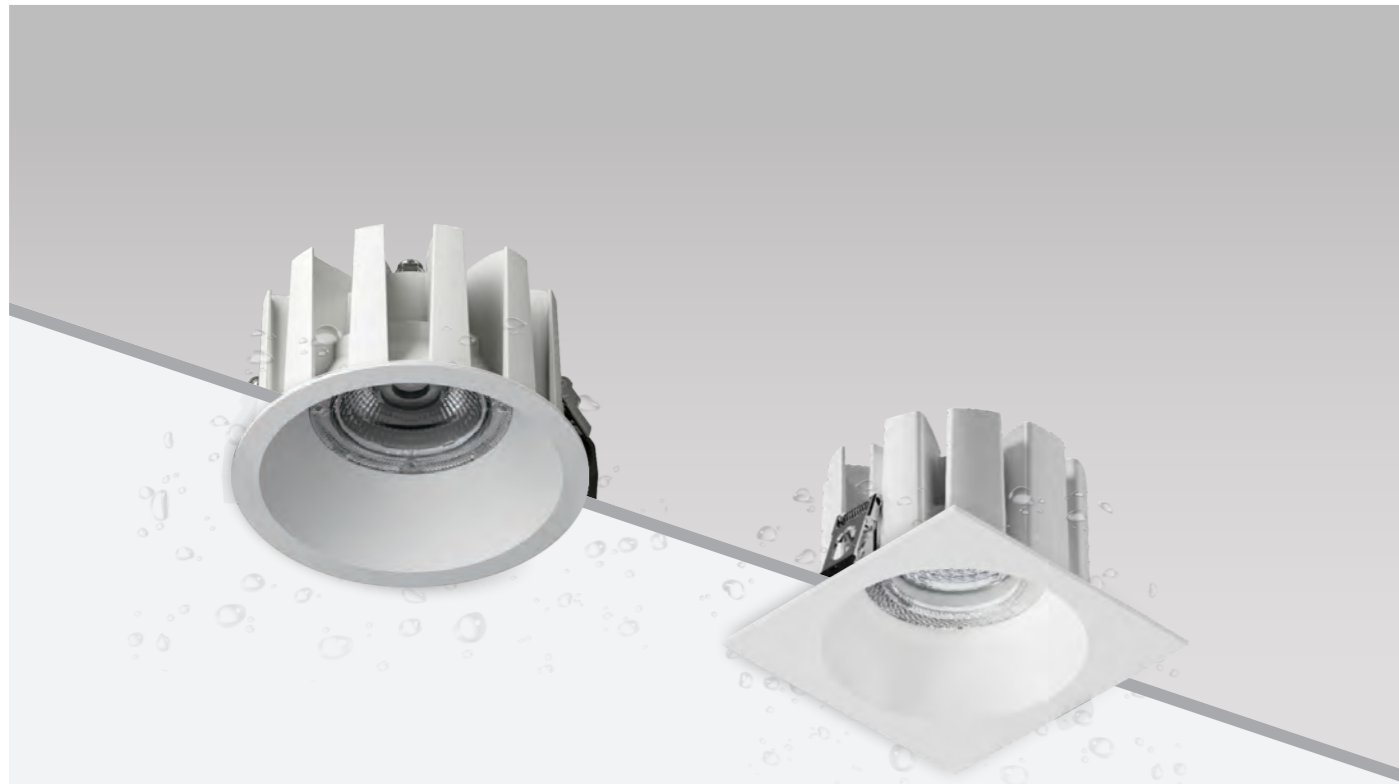

# WILL

## IP65 WATERPROOF DOWN LIGHT

The WILL series of recessed downlight adopts high lumen LED chip and PC lens /reflector which make sure the high luminous, die-casting aluminum housing provides excellent heat dissipation  
The installation is very easy, the front face is with IP65 protection level

### SPLIT STRUCTURE

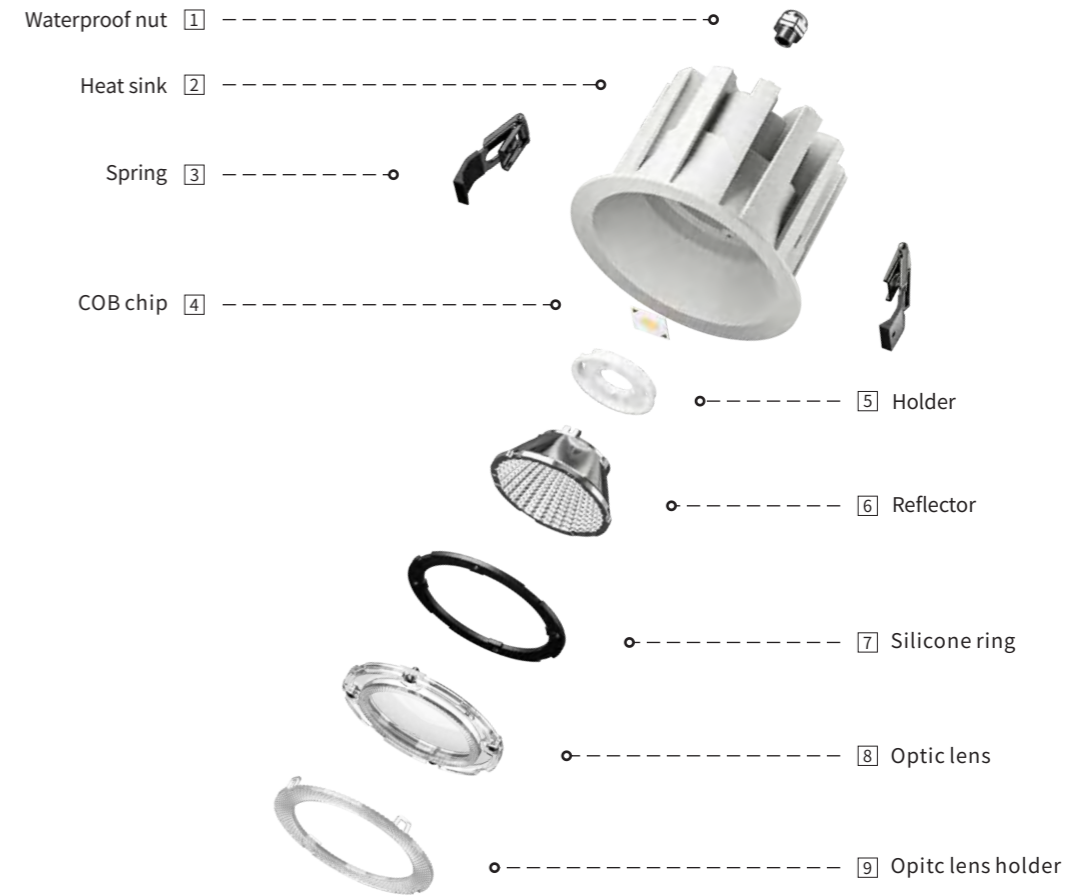

Optional reflector



Optional lens



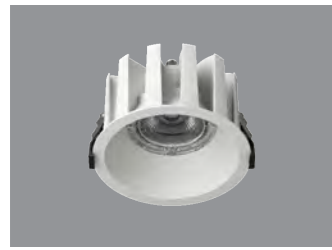

- **CCT:** 2700K/3000K/3500K/4000K/5700K
- **Finish:** White/Black
- **Driver:** Eaglerise/Philips/Tridonic
- **Light source:** COB LED  
Luminus/CREE/Bridgelux

| Model Code | Power | LED Current | Lumen (±5%) | Beam angle      | Input voltage         | CRI               | Dimming                  |
|------------|-------|-------------|-------------|-----------------|-----------------------|-------------------|--------------------------|
| DL07R25    | 12W   | 300mA       | 1050 lm     | 15° 24° 36° 55° | AC220-240V<br>50/60Hz | ≥80<br>≥90<br>≥97 | Triac<br>Dali<br>0/1-10V |

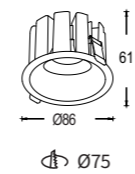

| Model Code | Power | LED Current | Lumen (±5%) | Beam angle      | Input voltage         | CRI               | Dimming                  |
|------------|-------|-------------|-------------|-----------------|-----------------------|-------------------|--------------------------|
| DL07R30    | 20W   | 500mA       | 1800 lm     | 15° 24° 36° 55° | AC220-240V<br>50/60Hz | ≥80<br>≥90<br>≥97 | Triac<br>Dali<br>0/1-10V |

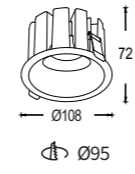

| Model Code | Power | LED Current | Lumen (±5%) | Beam angle      | Input voltage         | CRI               | Dimming                  |
|------------|-------|-------------|-------------|-----------------|-----------------------|-------------------|--------------------------|
| DL07R40    | 30W   | 700mA       | 2850 lm     | 15° 24° 36° 55° | AC220-240V<br>50/60Hz | ≥80<br>≥90<br>≥97 | Triac<br>Dali<br>0/1-10V |

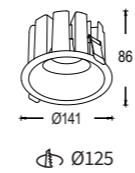

| Model Code | Power | LED Current | Lumen (±5%) | Beam angle      | Input voltage         | CRI               | Dimming                  |
|------------|-------|-------------|-------------|-----------------|-----------------------|-------------------|--------------------------|
| DL07R50    | 40W   | 950mA       | 3950 lm     | 15° 24° 36° 55° | AC220-240V<br>50/60Hz | ≥80<br>≥90<br>≥97 | Triac<br>Dali<br>0/1-10V |

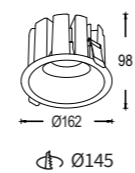

| Model Code | Power | LED Current | Lumen (±5%) | Beam angle      | Input voltage         | CRI               | Dimming                  |
|------------|-------|-------------|-------------|-----------------|-----------------------|-------------------|--------------------------|
| DL07R60    | 50W   | 1200mA      | 5000 lm     | 15° 24° 36° 55° | AC220-240V<br>50/60Hz | ≥80<br>≥90<br>≥97 | Triac<br>Dali<br>0/1-10V |

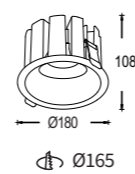

| Model Code | Power | LED Current | Lumen (±5%) | Beam angle      | Input voltage         | CRI               | Dimming                  |
|------------|-------|-------------|-------------|-----------------|-----------------------|-------------------|--------------------------|
| DL07R80    | 60W   | 1400mA      | 6000 lm     | 15° 24° 36° 55° | AC220-240V<br>50/60Hz | ≥80<br>≥90<br>≥97 | Triac<br>Dali<br>0/1-10V |

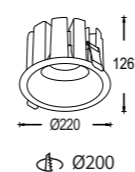

Optional reflector      Optional lens

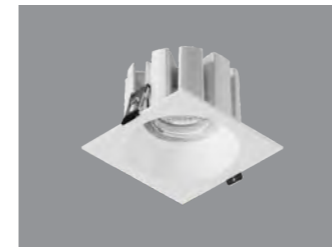

- **CCT:** 2700K/3000K/3500K/4000K/5700K
- **Finish:** White/Black
- **Driver:** Eaglerise/Philips/Tridonic
- **Light source:** COB LED  
Luminus/CREE/Bridgelux

| Model Code | Power | LED Current | Lumen (±5%) | Beam angle      | Input voltage         | CRI               | Dimming                  |
|------------|-------|-------------|-------------|-----------------|-----------------------|-------------------|--------------------------|
| DL07S25    | 12W   | 300mA       | 1050 lm     | 15° 24° 36° 55° | AC220-240V<br>50/60Hz | ≥80<br>≥90<br>≥97 | Triac<br>Dali<br>0/1-10V |

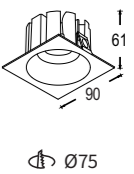

| Model Code | Power | LED Current | Lumen (±5%) | Beam angle      | Input voltage         | CRI               | Dimming                  |
|------------|-------|-------------|-------------|-----------------|-----------------------|-------------------|--------------------------|
| DL07S30    | 20W   | 500mA       | 1800 lm     | 15° 24° 36° 55° | AC220-240V<br>50/60Hz | ≥80<br>≥90<br>≥97 | Triac<br>Dali<br>0/1-10V |

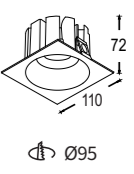

| Model Code | Power | LED Current | Lumen (±5%) | Beam angle      | Input voltage         | CRI               | Dimming                  |
|------------|-------|-------------|-------------|-----------------|-----------------------|-------------------|--------------------------|
| DL07S40    | 30W   | 700mA       | 2850 lm     | 15° 24° 36° 55° | AC220-240V<br>50/60Hz | ≥80<br>≥90<br>≥97 | Triac<br>Dali<br>0/1-10V |

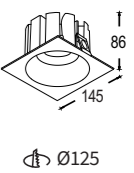

| Model Code | Power | LED Current | Lumen (±5%) | Beam angle      | Input voltage         | CRI               | Dimming                  |
|------------|-------|-------------|-------------|-----------------|-----------------------|-------------------|--------------------------|
| DL07S50    | 40W   | 950mA       | 3950 lm     | 15° 24° 36° 55° | AC220-240V<br>50/60Hz | ≥80<br>≥90<br>≥97 | Triac<br>Dali<br>0/1-10V |

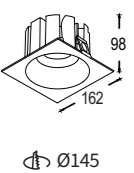

| Model Code | Power | LED Current | Lumen (±5%) | Beam angle      | Input voltage         | CRI               | Dimming                  |
|------------|-------|-------------|-------------|-----------------|-----------------------|-------------------|--------------------------|
| DL07S60    | 50W   | 1200mA      | 5000 lm     | 15° 24° 36° 55° | AC220-240V<br>50/60Hz | ≥80<br>≥90<br>≥97 | Triac<br>Dali<br>0/1-10V |

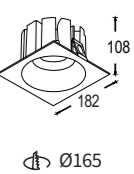

| Model Code | Power | LED Current | Lumen (±5%) | Beam angle      | Input voltage         | CRI               | Dimming                  |
|------------|-------|-------------|-------------|-----------------|-----------------------|-------------------|--------------------------|
| DL07S80    | 60W   | 1400mA      | 6000 lm     | 15° 24° 36° 55° | AC220-240V<br>50/60Hz | ≥80<br>≥90<br>≥97 | Triac<br>Dali<br>0/1-10V |

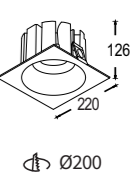

Optional reflector      Optional lens

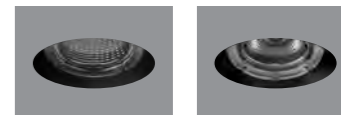

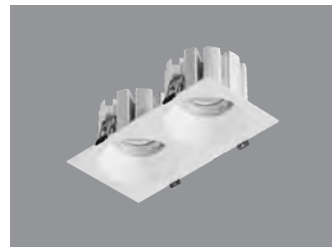

| Model Code | Power | LED Current | Lumen (±5%) | Beam angle      | Input voltage         | CRI               | Dimming                  |
|------------|-------|-------------|-------------|-----------------|-----------------------|-------------------|--------------------------|
| DL07S25-2  | 2x12W | 300mA       | 2050 lm     | 15° 24° 36° 55° | AC220-240V<br>50/60Hz | ≥80<br>≥90<br>≥97 | Triac<br>Dali<br>0/1-10V |

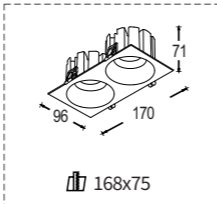

- **CCT:**  
2700K/3000K/3500K/4000K/5700K
- **Finish:**  
White/Black
- **Driver:**  
Eaglerise/Philips/Tridonic
- **Light source:**  
COB LED  
Luminus/CREE/Bridgelux

| Model Code | Power | LED Current | Lumen (±5%) | Beam angle      | Input voltage         | CRI               | Dimming                  |
|------------|-------|-------------|-------------|-----------------|-----------------------|-------------------|--------------------------|
| DL07S30-2  | 2x20W | 500mA       | 3750 lm     | 15° 24° 36° 55° | AC220-240V<br>50/60Hz | ≥80<br>≥90<br>≥97 | Triac<br>Dali<br>0/1-10V |

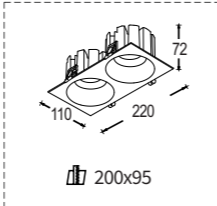

| Model Code | Power | LED Current | Lumen (±5%) | Beam angle      | Input voltage         | CRI               | Dimming                  |
|------------|-------|-------------|-------------|-----------------|-----------------------|-------------------|--------------------------|
| DL07S40-2  | 2x30W | 700mA       | 5800 lm     | 15° 24° 36° 55° | AC220-240V<br>50/60Hz | ≥80<br>≥90<br>≥97 | Triac<br>Dali<br>0/1-10V |

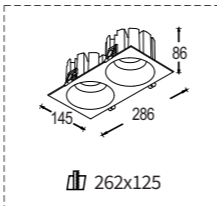

Optional reflector

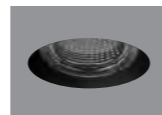

Optional lens

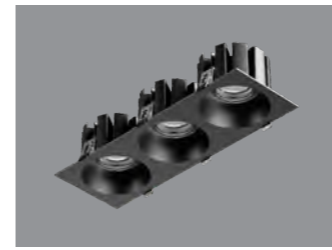
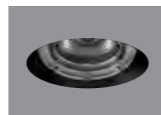

| Model Code | Power | LED Current | Lumen (±5%) | Beam angle      | Input voltage         | CRI               | Dimming                  |
|------------|-------|-------------|-------------|-----------------|-----------------------|-------------------|--------------------------|
| DL07S25-3  | 3x12W | 300mA       | 3050 lm     | 15° 24° 36° 55° | AC220-240V<br>50/60Hz | ≥80<br>≥90<br>≥97 | Triac<br>Dali<br>0/1-10V |

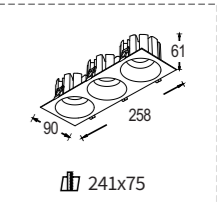

- **CCT:**  
2700K/3000K/3500K/4000K/5700K
- **Finish:**  
White/Black
- **Driver:**  
Eaglerise/Philips/Tridonic
- **Light source:**  
COB LED  
Luminus/CREE/Bridgelux

| Model Code | Power | LED Current | Lumen (±5%) | Beam angle      | Input voltage         | CRI               | Dimming                  |
|------------|-------|-------------|-------------|-----------------|-----------------------|-------------------|--------------------------|
| DL07S30-3  | 3x20W | 500mA       | 5500 lm     | 15° 24° 36° 55° | AC220-240V<br>50/60Hz | ≥80<br>≥90<br>≥97 | Triac<br>Dali<br>0/1-10V |

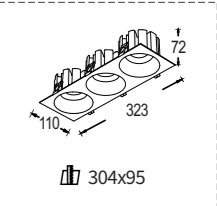

| Model Code | Power | LED Current | Lumen (±5%) | Beam angle      | Input voltage         | CRI               | Dimming                  |
|------------|-------|-------------|-------------|-----------------|-----------------------|-------------------|--------------------------|
| DL07S40-3  | 3x30W | 700mA       | 8650 lm     | 15° 24° 36° 55° | AC220-240V<br>50/60Hz | ≥80<br>≥90<br>≥97 | Triac<br>Dali<br>0/1-10V |

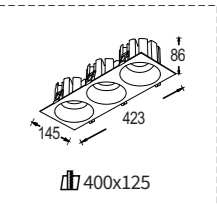

Optional reflector

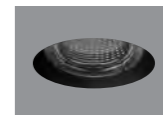

Optional lens

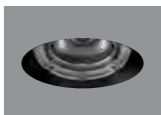

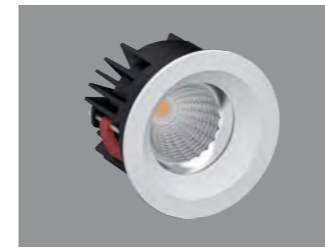

- **CCT:**  
2700K/3000K/3500K/4000K/5000K
- **Finish:**  
White/Black
- **Driver:**  
Eaglerise/Philips/Tridonic
- **Light source:**  
COB LED  
Luminus/CREE/Bridgelux

| Model Code | Power | LED Current | Lumen (±5%) | Beam angle  | Input voltage         | CRI               | Dimming                  |
|------------|-------|-------------|-------------|-------------|-----------------------|-------------------|--------------------------|
| DL05R25    | 12W   | 300mA       | 1050 lm     | 20° 40° 60° | AC220-240V<br>50/60Hz | ≥80<br>≥90<br>≥97 | Triac<br>Dali<br>0/1-10V |

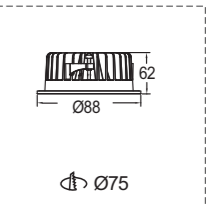

| Model Code | Power | LED Current | Lumen (±5%) | Beam angle  | Input voltage         | CRI               | Dimming                  |
|------------|-------|-------------|-------------|-------------|-----------------------|-------------------|--------------------------|
| DL05R30    | 18W   | 450mA       | 1650 lm     | 20° 40° 60° | AC220-240V<br>50/60Hz | ≥80<br>≥90<br>≥97 | Triac<br>Dali<br>0/1-10V |

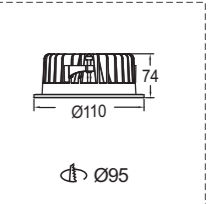

| Model Code | Power | LED Current | Lumen (±5%) | Beam angle  | Input voltage         | CRI               | Dimming                  |
|------------|-------|-------------|-------------|-------------|-----------------------|-------------------|--------------------------|
| DL05R40    | 25W   | 600mA       | 2250 lm     | 20° 40° 60° | AC220-240V<br>50/60Hz | ≥80<br>≥90<br>≥97 | Triac<br>Dali<br>0/1-10V |

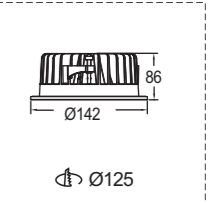

| Model Code | Power | LED Current | Lumen (±5%) | Beam angle  | Input voltage         | CRI               | Dimming                  |
|------------|-------|-------------|-------------|-------------|-----------------------|-------------------|--------------------------|
| DL05R50    | 30W   | 700mA       | 2760 lm     | 20° 40° 60° | AC220-240V<br>50/60Hz | ≥80<br>≥90<br>≥97 | Triac<br>Dali<br>0/1-10V |

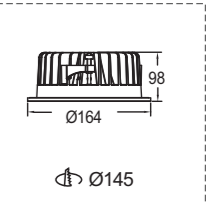

| Model Code | Power | LED Current | Lumen (±5%) | Beam angle  | Input voltage         | CRI               | Dimming                  |
|------------|-------|-------------|-------------|-------------|-----------------------|-------------------|--------------------------|
| DL05R60    | 35W   | 850mA       | 3400 lm     | 20° 40° 60° | AC220-240V<br>50/60Hz | ≥80<br>≥90<br>≥97 | Triac<br>Dali<br>0/1-10V |

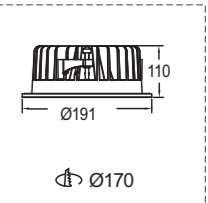

| Model Code | Power | LED Current | Lumen (±5%) | Beam angle  | Input voltage         | CRI               | Dimming                  |
|------------|-------|-------------|-------------|-------------|-----------------------|-------------------|--------------------------|
| DL05R80    | 45W   | 1200mA      | 4450 lm     | 20° 40° 60° | AC220-240V<br>50/60Hz | ≥80<br>≥90<br>≥97 | Triac<br>Dali<br>0/1-10V |

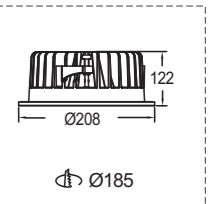

Product Image



Step-prisma diffuser

Flat-prisma diffuser

# HALO

## LED DOWNLIGHT

UGR<19 ANTI-GLARE RATING, HEALTHY AND EYE-PROTECTING  
 THERE ARE FOUR COLORS OF REFLECTOR CUPS TO CHOOSE FROM, ALLOWING YOU TO MATCH THEM AS YOU LIKE  
 FLAT PRISM DIFFUSERS OR STEP PRISM DIFFUSERS ARE OPTIONAL, 92% LIGHT TRANSMISSION



- CCT: 3000K/4000K/6000K
- Finish: White/Black
- Light source: SMD CHIP

| Model Code | Power | LED Current | Lumen (±5%) | Beam angle | Input voltage         | CRI        | Dimming                  |
|------------|-------|-------------|-------------|------------|-----------------------|------------|--------------------------|
| DL04R25    | 7W    | 180mA       | 980 lm      | 50° 100°   | AC220-240V<br>50/60Hz | ≥80<br>≥90 | Triac<br>Dali<br>0/1-10V |

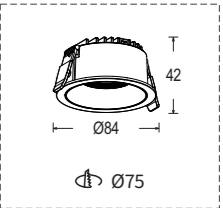

| Model Code | Power | LED Current | Lumen (±5%) | Beam angle | Input voltage         | CRI        | Dimming                  |
|------------|-------|-------------|-------------|------------|-----------------------|------------|--------------------------|
| DL04R28    | 9W    | 200mA       | 1200 lm     | 50° 100°   | AC220-240V<br>50/60Hz | ≥80<br>≥90 | Triac<br>Dali<br>0/1-10V |

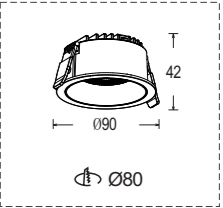

| Model Code | Power | LED Current | Lumen (±5%) | Beam angle | Input voltage         | CRI        | Dimming                  |
|------------|-------|-------------|-------------|------------|-----------------------|------------|--------------------------|
| DL04R30    | 12W   | 300mA       | 1642 lm     | 50° 100°   | AC220-240V<br>50/60Hz | ≥80<br>≥90 | Triac<br>Dali<br>0/1-10V |

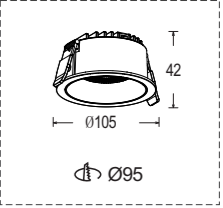

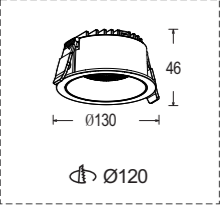

| Model Code | Power | LED Current | Lumen (±5%) | Beam angle | Input voltage         | CRI        | Dimming                  |
|------------|-------|-------------|-------------|------------|-----------------------|------------|--------------------------|
| DL04R40    | 18W   | 450mA       | 2674 lm     | 50° 100°   | AC220-240V<br>50/60Hz | ≥80<br>≥90 | Triac<br>Dali<br>0/1-10V |

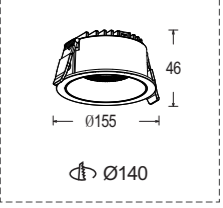

| Model Code | Power | LED Current | Lumen (±5%) | Beam angle | Input voltage         | CRI        | Dimming                  |
|------------|-------|-------------|-------------|------------|-----------------------|------------|--------------------------|
| DL04R50    | 20W   | 500mA       | 2920 lm     | 50° 100°   | AC220-240V<br>50/60Hz | ≥80<br>≥90 | Triac<br>Dali<br>0/1-10V |



- Colour:    
- White Black Bright silver Chrome black

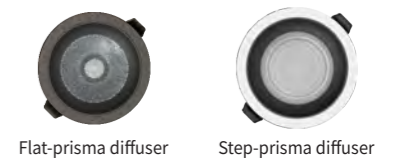

Flat-prisma diffuser

Step-prisma diffuser

LED downlight



| Model Code | Power | LED Current | Lumen (±5%) | Beam angle | Input voltage         | CRI        | Dimming                  |
|------------|-------|-------------|-------------|------------|-----------------------|------------|--------------------------|
| DL04R60    | 25W   | 600mA       | 3650 lm     | 50° 100°   | AC220-240V<br>50/60Hz | ≥80<br>≥90 | Triac<br>Dali<br>0/1-10V |

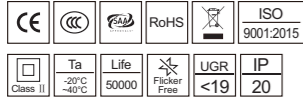
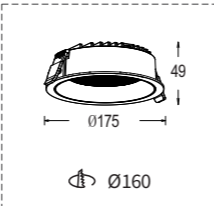

- **CCT:**  
3000K/4000K/6000K
- **Finish:**  
White/Black
- **Light source:**  
SMD CHIP

| Model Code | Power | LED Current | Lumen (±5%) | Beam angle | Input voltage         | CRI        | Dimming                  |
|------------|-------|-------------|-------------|------------|-----------------------|------------|--------------------------|
| DL04R80    | 30W   | 700mA       | 4810 lm     | 50° 100°   | AC220-240V<br>50/60Hz | ≥80<br>≥90 | Triac<br>Dali<br>0/1-10V |

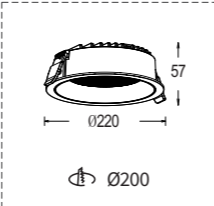

| Model Code | Power | LED Current | Lumen (±5%) | Beam angle | Input voltage         | CRI        | Dimming                  |
|------------|-------|-------------|-------------|------------|-----------------------|------------|--------------------------|
| DL04R100   | 40W   | 950mA       | 5920 lm     | 50° 100°   | AC220-240V<br>50/60Hz | ≥80<br>≥90 | Triac<br>Dali<br>0/1-10V |

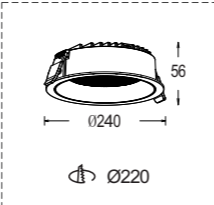

| Model Code | Power | LED Current | Lumen (±5%) | Beam angle | Input voltage         | CRI        | Dimming                  |
|------------|-------|-------------|-------------|------------|-----------------------|------------|--------------------------|
| DL04R120   | 50W   | 1200mA      | 7250 lm     | 50° 100°   | AC220-240V<br>50/60Hz | ≥80<br>≥90 | Triac<br>Dali<br>0/1-10V |

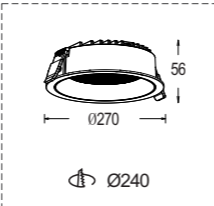

| Model Code | Power | LED Current | Lumen (±5%) | Beam angle | Input voltage         | CRI        | Dimming                  |
|------------|-------|-------------|-------------|------------|-----------------------|------------|--------------------------|
| DL04R140   | 60W   | 1500mA      | 8700 lm     | 50° 100°   | AC220-240V<br>50/60Hz | ≥80<br>≥90 | Triac<br>Dali<br>0/1-10V |

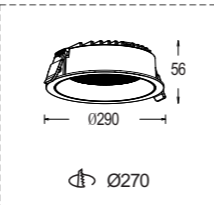

Colour:

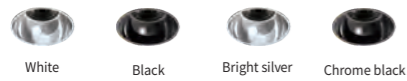

HALO



| Model Code | Power | LED Current | Lumen (±5%) | Beam angle      | Input voltage         | CRI        | Dimming                  |
|------------|-------|-------------|-------------|-----------------|-----------------------|------------|--------------------------|
| DL04R30A   | 12W   | 300mA       | 1050 lm     | 15° 24° 36° 55° | AC220-240V<br>50/60Hz | ≥80<br>≥90 | Triac<br>Dali<br>0/1-10V |

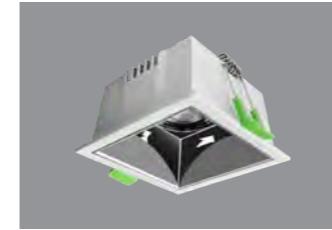
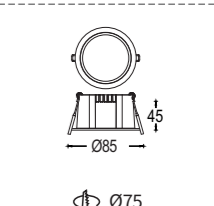

| Model Code | Power | LED Current | Lumen (±5%) | Beam angle      | Input voltage         | CRI        | Dimming                  |
|------------|-------|-------------|-------------|-----------------|-----------------------|------------|--------------------------|
| DL04S30A   | 12W   | 300mA       | 1050 lm     | 15° 24° 36° 55° | AC220-240V<br>50/60Hz | ≥80<br>≥90 | Triac<br>Dali<br>0/1-10V |

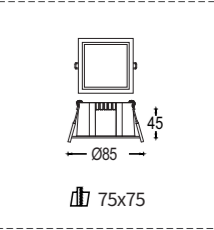

- **CCT:**  
2700K/3000K/3500K/4000K/5700K
- **Finish:**  
White/Black
- **Light source:**  
COB LED  
Luminus/CREE/Bridgelux

Colour:





### Triple anti-glare

The combined use of a triple-reflector and a reflective lens achieves a high standard of visual comfort with a Unified Glare Rating (UGR) of  $\leq 16$ , significantly reducing glare and enhancing the user's comfort experience.

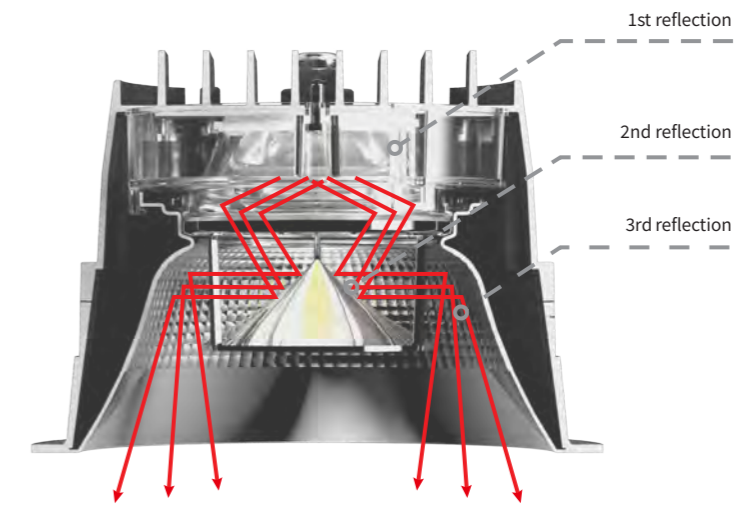

Triple anti-glare reflector

+



Triple reflective lens

#### Optics for option



High light-transmission lens   Triple anti-glare reflector   Diffuser Lens   Honeycomb

#### Reflector color



White   Black   MattSilver   Bright Silver

### Extension out ring

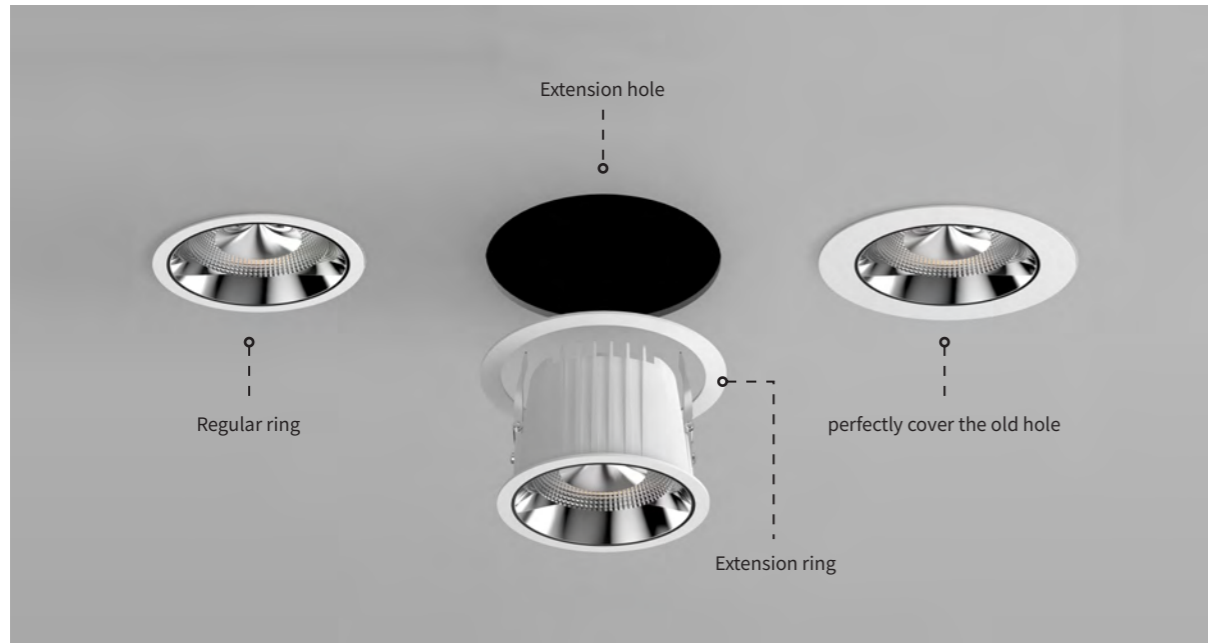

### IP54

Dustproof and waterproof

IP54 waterproof design to withstand environments such as bathrooms, kitchens and toilets that easily effect by water, fog and fumes



waterproof screws

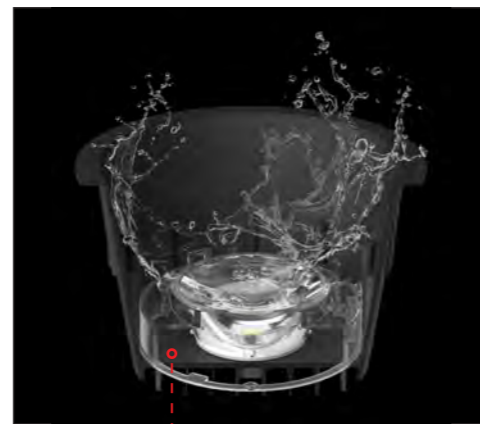

sealed cover inside

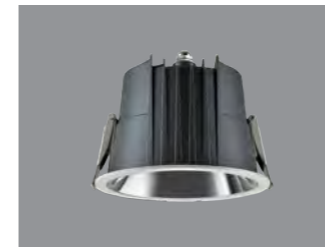

- **CCT:** 2700K/3000K/3500K/4000K/5700K
- **Finish:** White/Black/Grey
- **Driver:** Eaglerise/Philips/Tridonic
- **Light source:** COB LED Luminus/CREE/Bridgelux

| Model Code | Power | LED Current | Lumen (±5%) | Beam angle | Input voltage      | CRI               | Dimming                  |
|------------|-------|-------------|-------------|------------|--------------------|-------------------|--------------------------|
| DL03R25    | 9W    | 200mA       | 750 lm      | 24° 60°    | AC220-240V 50/60Hz | ≥80<br>≥90<br>≥97 | Triac<br>Dali<br>0/1-10V |

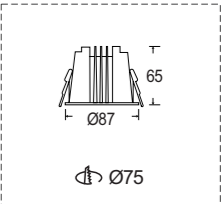

| Model Code | Power | LED Current | Lumen (±5%) | Beam angle | Input voltage      | CRI               | Dimming                  |
|------------|-------|-------------|-------------|------------|--------------------|-------------------|--------------------------|
| DL03R40    | 15W   | 350mA       | 1200 lm     | 24° 60°    | AC220-240V 50/60Hz | ≥80<br>≥90<br>≥97 | Triac<br>Dali<br>0/1-10V |

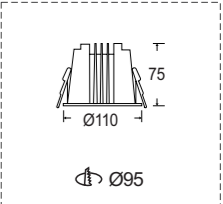

| Model Code | Power | LED Current | Lumen (±5%) | Beam angle | Input voltage      | CRI               | Dimming                  |
|------------|-------|-------------|-------------|------------|--------------------|-------------------|--------------------------|
| DL03R50    | 24W   | 600mA       | 2100 lm     | 24° 60°    | AC220-240V 50/60Hz | ≥80<br>≥90<br>≥97 | Triac<br>Dali<br>0/1-10V |

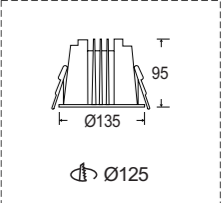

| Model Code | Power | LED Current | Lumen (±5%) | Beam angle | Input voltage      | CRI               | Dimming                  |
|------------|-------|-------------|-------------|------------|--------------------|-------------------|--------------------------|
| DL03R60    | 35W   | 850mA       | 3200 lm     | 24° 60°    | AC220-240V 50/60Hz | ≥80<br>≥90<br>≥97 | Triac<br>Dali<br>0/1-10V |

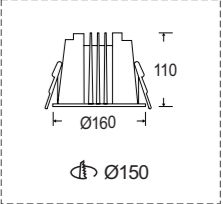

| Model Code | Power | LED Current | Lumen (±5%) | Beam angle | Input voltage      | CRI               | Dimming                  |
|------------|-------|-------------|-------------|------------|--------------------|-------------------|--------------------------|
| DL03R70    | 45W   | 1200mA      | 4350 lm     | 24° 60°    | AC220-240V 50/60Hz | ≥80<br>≥90<br>≥97 | Triac<br>Dali<br>0/1-10V |

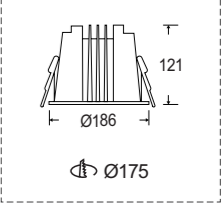

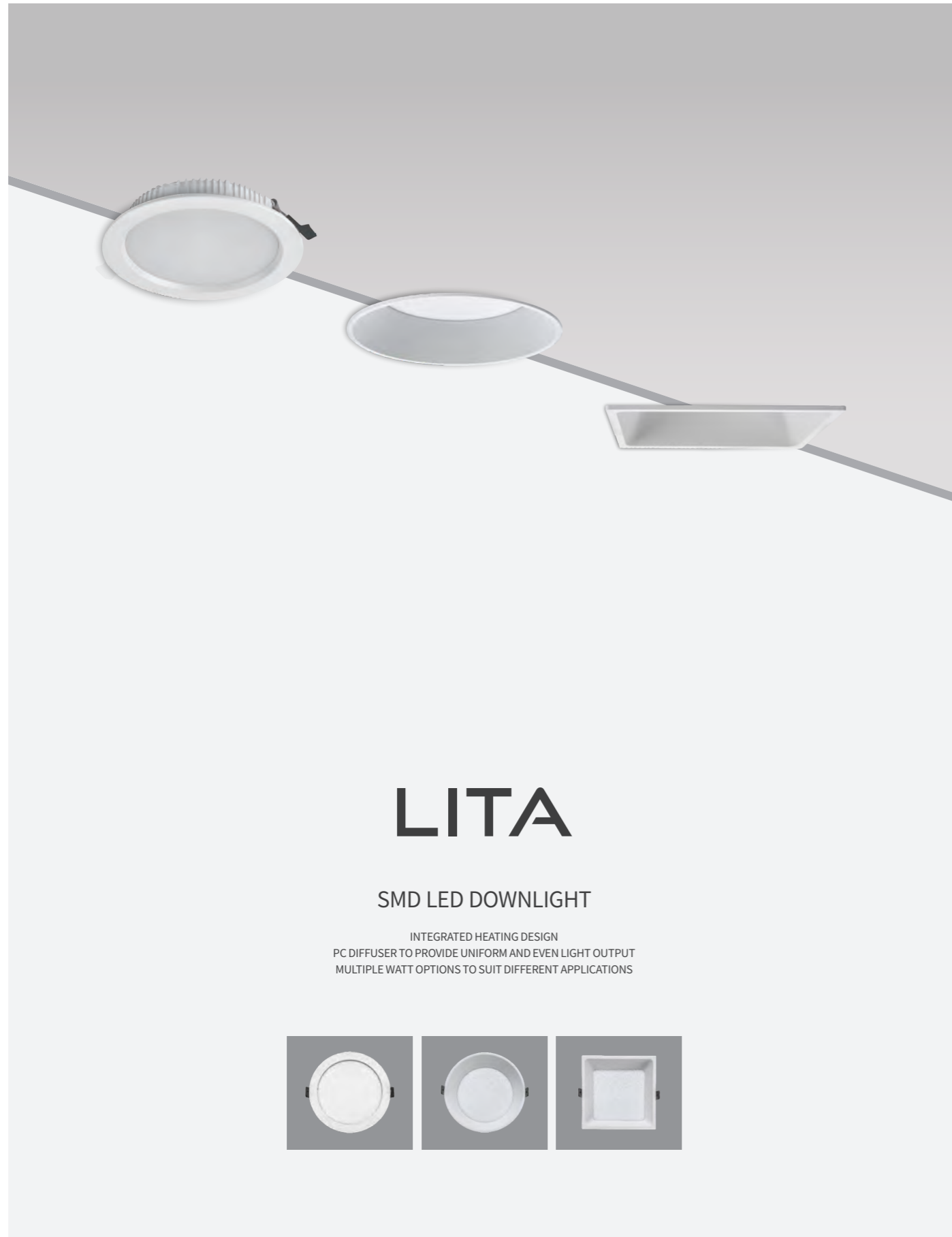

# LITA

## SMD LED DOWNLIGHT

INTEGRATED HEATING DESIGN  
PC DIFFUSER TO PROVIDE UNIFORM AND EVEN LIGHT OUTPUT  
MULTIPLE WATT OPTIONS TO SUIT DIFFERENT APPLICATIONS



- **CCT:**  
3000K/4000K/6000K
- **Finish:**  
White/Black
- **Driver:**  
Eaglerise/Philips/Tridonic
- **Light source:**  
SMD LED

| Model Code | Power | LED Current | Lumen (±5%) | Beam angle | Input voltage         | CRI        | Dimming                  |
|------------|-------|-------------|-------------|------------|-----------------------|------------|--------------------------|
| LD409G     | 5W    | 150mA       | 400 lm      | 90°        | AC220-240V<br>50/60Hz | ≥80<br>≥90 | Triac<br>Dali<br>0/1-10V |

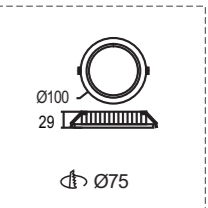

| Model Code | Power | LED Current | Lumen (±5%) | Beam angle | Input voltage         | CRI        | Dimming                  |
|------------|-------|-------------|-------------|------------|-----------------------|------------|--------------------------|
| LD411G     | 9W    | 200mA       | 800 lm      | 90°        | AC220-240V<br>50/60Hz | ≥80<br>≥90 | Triac<br>Dali<br>0/1-10V |

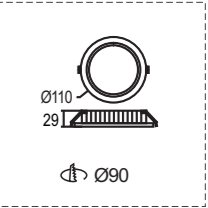

| Model Code | Power | LED Current | Lumen (±5%) | Beam angle | Input voltage         | CRI        | Dimming                  |
|------------|-------|-------------|-------------|------------|-----------------------|------------|--------------------------|
| LD412G     | 12W   | 300mA       | 1200 lm     | 90°        | AC220-240V<br>50/60Hz | ≥80<br>≥90 | Triac<br>Dali<br>0/1-10V |

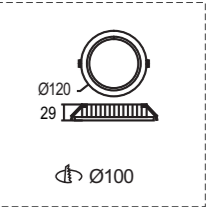

| Model Code | Power | LED Current | Lumen (±5%) | Beam angle | Input voltage         | CRI        | Dimming                  |
|------------|-------|-------------|-------------|------------|-----------------------|------------|--------------------------|
| LD415G     | 15W   | 350mA       | 1500 lm     | 90°        | AC220-240V<br>50/60Hz | ≥80<br>≥90 | Triac<br>Dali<br>0/1-10V |

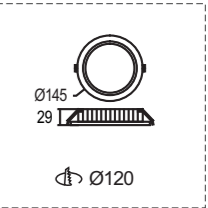

| Model Code | Power | LED Current | Lumen (±5%) | Beam angle | Input voltage         | CRI        | Dimming                  |
|------------|-------|-------------|-------------|------------|-----------------------|------------|--------------------------|
| LD418G     | 20W   | 500mA       | 2000 lm     | 90°        | AC220-240V<br>50/60Hz | ≥80<br>≥90 | Triac<br>Dali<br>0/1-10V |

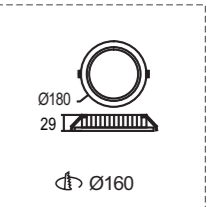

| Model Code | Power | LED Current | Lumen (±5%) | Beam angle | Input voltage         | CRI        | Dimming                  |
|------------|-------|-------------|-------------|------------|-----------------------|------------|--------------------------|
| LD419G     | 25W   | 600mA       | 2500 lm     | 90°        | AC220-240V<br>50/60Hz | ≥80<br>≥90 | Triac<br>Dali<br>0/1-10V |

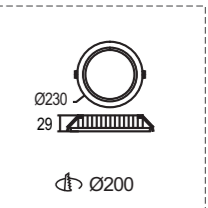



| Model Code | Power | LED Current | Lumen (±5%) | Beam angle | Input voltage         | CRI        | Dimming                  |  |
|------------|-------|-------------|-------------|------------|-----------------------|------------|--------------------------|--|
| DL02R30    | 12W   | 300mA       | 1250 lm     | 90°        | AC220-240V<br>50/60Hz | ≥80<br>≥90 | Triac<br>Dali<br>0/1-10V |  |



- **CCT:** 3000K/4000K/6000K
- **Finish:** White/Black
- **Driver:** Eaglerise/Philips/Tridonic
- **Light source:** SMD LED

| Model Code | Power | LED Current | Lumen (±5%) | Beam angle | Input voltage         | CRI        | Dimming                  |  |
|------------|-------|-------------|-------------|------------|-----------------------|------------|--------------------------|--|
| DL02R40    | 18W   | 450mA       | 1950 lm     | 90°        | AC220-240V<br>50/60Hz | ≥80<br>≥90 | Triac<br>Dali<br>0/1-10V |  |

| Model Code | Power | LED Current | Lumen (±5%) | Beam angle | Input voltage         | CRI        | Dimming                  |  |
|------------|-------|-------------|-------------|------------|-----------------------|------------|--------------------------|--|
| DL02R60    | 24W   | 600mA       | 2650 lm     | 90°        | AC220-240V<br>50/60Hz | ≥80<br>≥90 | Triac<br>Dali<br>0/1-10V |  |



| Model Code | Power | LED Current | Lumen (±5%) | Beam angle | Input voltage         | CRI        | Dimming                  |  |
|------------|-------|-------------|-------------|------------|-----------------------|------------|--------------------------|--|
| DL02S30    | 12W   | 300mA       | 1250 lm     | 90°        | AC220-240V<br>50/60Hz | ≥80<br>≥90 | Triac<br>Dali<br>0/1-10V |  |



- **CCT:** 3000K/4000K/6000K
- **Finish:** White/Black
- **Driver:** Eaglerise/Philips/Tridonic
- **Light source:** SMD LED

| Model Code | Power | LED Current | Lumen (±5%) | Beam angle | Input voltage         | CRI        | Dimming                  |  |
|------------|-------|-------------|-------------|------------|-----------------------|------------|--------------------------|--|
| DL02S40    | 18W   | 450mA       | 1950 lm     | 90°        | AC220-240V<br>50/60Hz | ≥80<br>≥90 | Triac<br>Dali<br>0/1-10V |  |

| Model Code | Power | LED Current | Lumen (±5%) | Beam angle | Input voltage         | CRI        | Dimming                  |  |
|------------|-------|-------------|-------------|------------|-----------------------|------------|--------------------------|--|
| DL02S60    | 24W   | 600mA       | 2650 lm     | 90°        | AC220-240V<br>50/60Hz | ≥80<br>≥90 | Triac<br>Dali<br>0/1-10V |  |





# CAVO

## LED DOWNLIGHT

THE CAVO SERIES ADOPTS WITH AL6063 ALUMINIUM HEATSINK  
IT HAS SUPER GREAT HEAT DISSIPATION EFFECT  
THE SUPER NARROW FRONT TRIM DESIGN CAN EFFECTIVELY REDUCE THE GLARE







## EU,ERP :130lm/W UGR<14

Deep anti-glare

The CAVO Series features a unique face frame design that achieves ultra-low glare, with a high-efficiency reflector delivering 130lm/W. Specifically engineered for direct lighting applications.

The new super confort optics achieves UGR<14 (hospital-grade glare control) and 5,419cd focused intensity for critical visual tasks.



Ultra-slim frame 1mm

| Energy Efficiency Class | Total main efficacy $\eta_{TM}$ (lm/w) |
|-------------------------|--|
| A                       | 210 $\leq\eta_{TM}$                    |
| B                       | 185 $\leq\eta_{TM}<210$                |
| C                       | 160 $\leq\eta_{TM}<185$                |
| D                       | 135 $\leq\eta_{TM}<160$                |
| E                       | 110 $\leq\eta_{TM}<135$                |
| F                       | 85 $\leq\eta_{TM}<110$                 |
| G                       | $\eta_{TM}<85$                         |



| Model Code | Power | LED Current | Lumen (±5%) | Beam angle  | Input voltage         | CRI        | Dimming                  |
|------------|-------|-------------|-------------|-------------|-----------------------|------------|--------------------------|
| DL12R45    | 7W    | 180mA       | 500 lm      | 15° 24° 36° | AC220-240V<br>50/60Hz | ≥90<br>≥97 | Triac<br>Dali<br>0/1-10V |

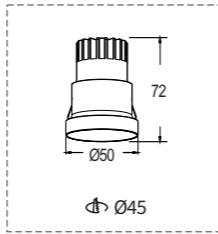

| Model Code | Power | LED Current | Lumen (±5%) | Beam angle  | Input voltage         | CRI        | Dimming                  |
|------------|-------|-------------|-------------|-------------|-----------------------|------------|--------------------------|
| DL12R85    | 15W   | 350mA       | 1250 lm     | 15° 24° 36° | AC220-240V<br>50/60Hz | ≥90<br>≥97 | Triac<br>Dali<br>0/1-10V |

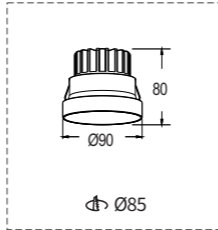

| Model Code | Power | LED Current | Lumen (±5%) | Beam angle  | Input voltage         | CRI        | Dimming                  |
|------------|-------|-------------|-------------|-------------|-----------------------|------------|--------------------------|
| DL12R115   | 20W   | 500mA       | 1850 lm     | 15° 24° 36° | AC220-240V<br>50/60Hz | ≥90<br>≥97 | Triac<br>Dali<br>0/1-10V |

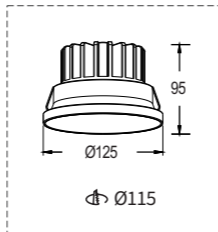

- **CCT:** 2700K/3000K/3500K/4000K/5700K
- **Finish:** White/Black
- **Light source:** COB LED  
Luminus/CREE/Bridgelux



| Model Code | Power | LED Current | Lumen (±5%) | Beam angle  | Input voltage         | CRI        | Dimming                  |
|------------|-------|-------------|-------------|-------------|-----------------------|------------|--------------------------|
| DL10R50    | 5W    | 120mA       | 300 lm      | 15° 24° 36° | AC220-240V<br>50/60Hz | ≥90<br>≥97 | Triac<br>Dali<br>0/1-10V |

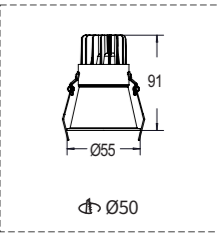

| Model Code | Power | LED Current | Lumen (±5%) | Beam angle  | Input voltage         | CRI        | Dimming                  |
|------------|-------|-------------|-------------|-------------|-----------------------|------------|--------------------------|
| DL10R70    | 10W   | 250mA       | 700 lm      | 15° 24° 36° | AC220-240V<br>50/60Hz | ≥90<br>≥97 | Triac<br>Dali<br>0/1-10V |

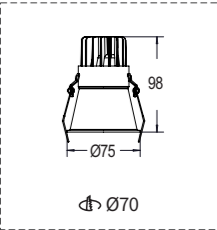

| Model Code | Power | LED Current | Lumen (±5%) | Beam angle  | Input voltage         | CRI        | Dimming                  |
|------------|-------|-------------|-------------|-------------|-----------------------|------------|--------------------------|
| DL10R85    | 15W   | 350mA       | 1100 lm     | 15° 24° 36° | AC220-240V<br>50/60Hz | ≥90<br>≥97 | Triac<br>Dali<br>0/1-10V |

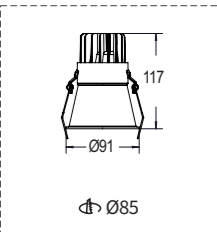

| Model Code | Power | LED Current | Lumen (±5%) | Beam angle  | Input voltage         | CRI        | Dimming                  |
|------------|-------|-------------|-------------|-------------|-----------------------|------------|--------------------------|
| DL10R120   | 20W   | 500mA       | 1650 lm     | 15° 24° 36° | AC220-240V<br>50/60Hz | ≥90<br>≥97 | Triac<br>Dali<br>0/1-10V |

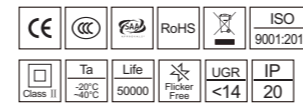
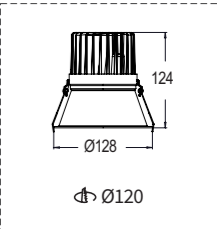

- **CCT:** 2700K/3000K/3500K/4000K/5700K
- **Finish:** White/Black
- **Light source:** COB LED  
Luminus/CREE/Bridgelux

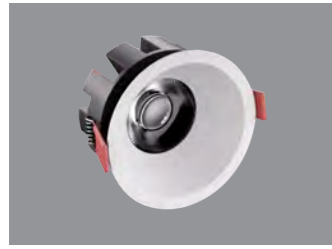

- **CCT:**  
2700K/3000K/3500K/4000K/5700K
- **Finish:**  
White/Black
- **Driver:**  
Eaglerise/Philips/Tridonic
- **Light source:**  
COB LED  
Luminus/CREE/Bridgelux

| Model Code | Power | LED Current | Lumen (±5%) | Beam angle      | Input voltage         | CRI        | Dimming                  |
|------------|-------|-------------|-------------|-----------------|-----------------------|------------|--------------------------|
| DL08R25    | 8W    | 200mA       | 650 lm      | 15° 24° 36° 50° | AC220-240V<br>50/60Hz | ≥90<br>≥97 | Triac<br>Dali<br>0/1-10V |

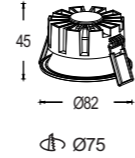

| Model Code | Power | LED Current | Lumen (±5%) | Beam angle      | Input voltage         | CRI        | Dimming                  |
|------------|-------|-------------|-------------|-----------------|-----------------------|------------|--------------------------|
| DL08R30    | 12W   | 300mA       | 1050 lm     | 15° 24° 36° 50° | AC220-240V<br>50/60Hz | ≥90<br>≥97 | Triac<br>Dali<br>0/1-10V |

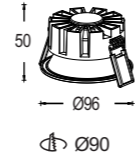

| Model Code | Power | LED Current | Lumen (±5%) | Beam angle      | Input voltage         | CRI        | Dimming                  |
|------------|-------|-------------|-------------|-----------------|-----------------------|------------|--------------------------|
| DL08R35    | 15W   | 350mA       | 1400 lm     | 15° 24° 36° 50° | AC220-240V<br>50/60Hz | ≥90<br>≥97 | Triac<br>Dali<br>0/1-10V |

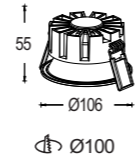

| Model Code | Power | LED Current | Lumen (±5%) | Beam angle      | Input voltage         | CRI        | Dimming                  |
|------------|-------|-------------|-------------|-----------------|-----------------------|------------|--------------------------|
| DL08R40    | 18W   | 450mA       | 1700 lm     | 15° 24° 36° 50° | AC220-240V<br>50/60Hz | ≥90<br>≥97 | Triac<br>Dali<br>0/1-10V |

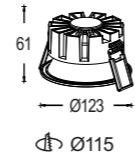

LED  
Magnetic  
light

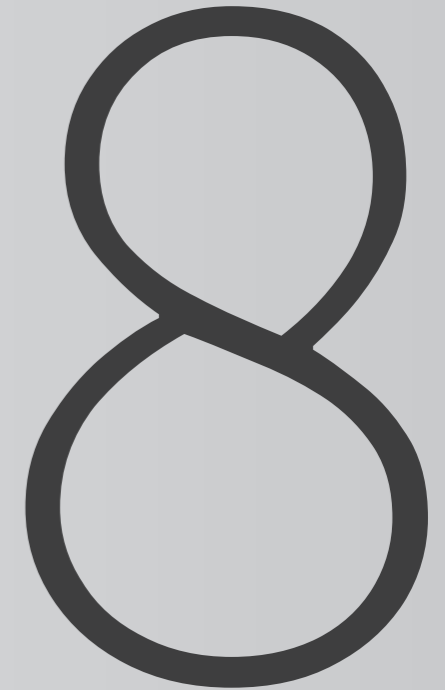

LED MAGNETIC LIGHT

NIKI.....003



# NIKI

## DC48V MAGNETIC LIGHT

THE NIKI SERIES ADOPTS TO DC48V MAGNETIC SYSTEM.IT CAN BE INSTALLED IN PLACES THAT ARE TOUCHED BY HANDS WITHOUT CAUSING ANY ELECTRIC SHOCKS. IN ORDER TO MEET WITH DIFFERENT DESIGNS ,NIKI RANGE CAN PROVIDE SURFACE MOUNTED , RECESSED , TRIMLESS AND PENDANT TYPES , AND CAN ADAPOT TO DIFFERENT SPOTLIGHTS/ FLOODLIGHTS/PENDANTS AND ALSO CAN RUN WITH NON-DIMMABLE/ DIMMABLE DALI/0-10V SYSTEMS.



Pendant track    Trimless recessed track    Pre-bury recessed track    Surface mounted track

### MULTIPLE OPTIONS FOR FREE COMBINATION

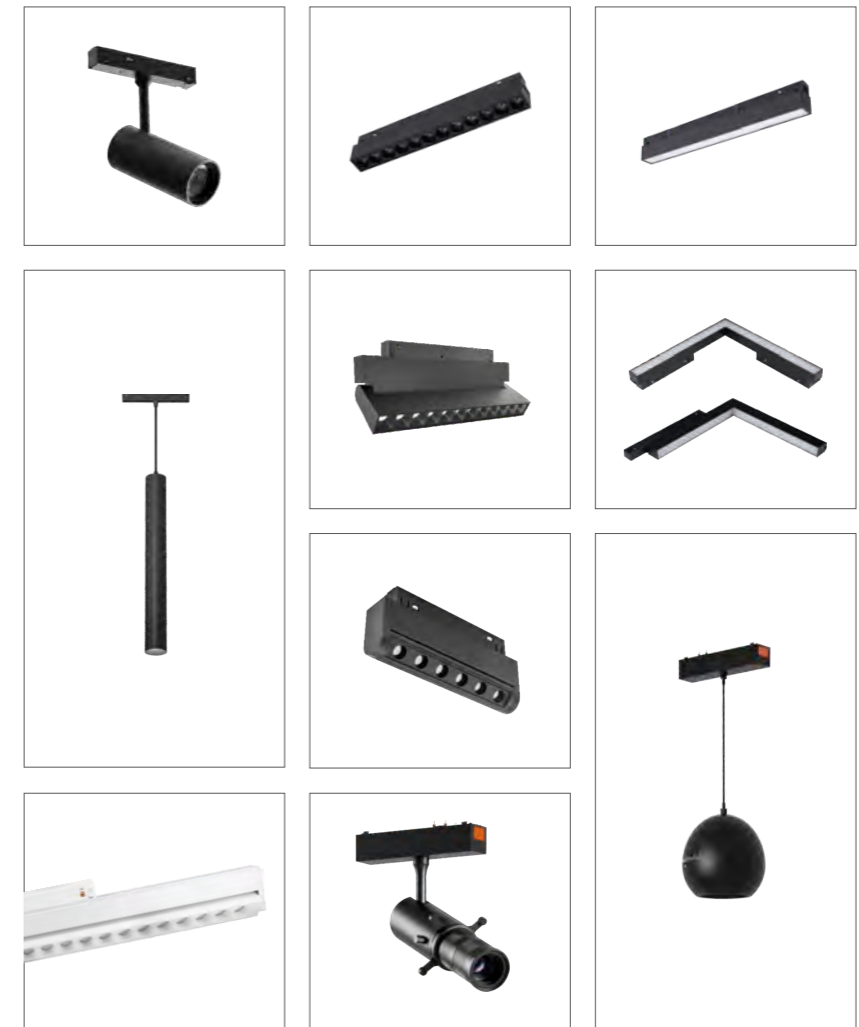



| Model Code | Power | LED Current | Lumen (±5%) | Beam angle  | Input voltage | CRI        | Dimming         |
|------------|-------|-------------|-------------|-------------|---------------|------------|-----------------|
| MT035      | 7W    | 180mA       | 560 lm      | 15° 24° 36° | DC 48V        | ≥90<br>≥97 | Dali<br>0/1-10V |

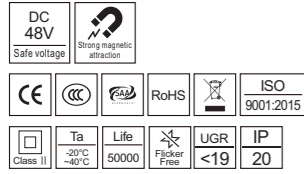
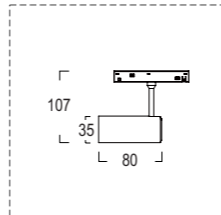

| Model Code | Power | LED Current | Lumen (±5%) | Beam angle  | Input voltage | CRI        | Dimming         |
|------------|-------|-------------|-------------|-------------|---------------|------------|-----------------|
| MT045      | 10W   | 250mA       | 800 lm      | 15° 24° 36° | DC 48V        | ≥90<br>≥97 | Dali<br>0/1-10V |

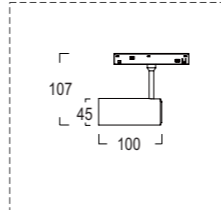

- **Swivel angle:**  
355° 90°
- **CCT:**  
2700K/3000K/3500K/4000K/5700K
- **Finish:**  
White/Black
- **Light source:**  
COB LED  
Luminus/CREE/Bridgelux

| Model Code | Power | LED Current | Lumen (±5%) | Beam angle  | Input voltage | CRI        | Dimming         |
|------------|-------|-------------|-------------|-------------|---------------|------------|-----------------|
| MT050      | 15W   | 350mA       | 1400 lm     | 15° 24° 36° | DC 48V        | ≥90<br>≥97 | Dali<br>0/1-10V |

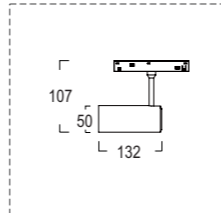

| Model Code | Power | LED Current | Lumen (±5%) | Beam angle  | Input voltage | CRI        | Dimming         |
|------------|-------|-------------|-------------|-------------|---------------|------------|-----------------|
| MT060      | 20W   | 500mA       | 2000 lm     | 15° 24° 36° | DC 48V        | ≥90<br>≥97 | Dali<br>0/1-10V |

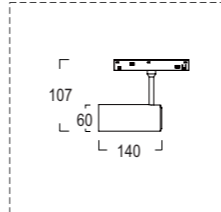

| Model Code | Power | LED Current | Lumen (±5%) | Beam angle  | Input voltage | CRI        | Dimming         |
|------------|-------|-------------|-------------|-------------|---------------|------------|-----------------|
| MT065      | 25W   | 600mA       | 2500 lm     | 15° 24° 36° | DC 48V        | ≥90<br>≥97 | Dali<br>0/1-10V |

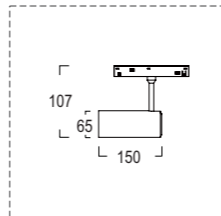

| Model Code | Power | LED Current | Lumen (±5%) | Beam angle  | Input voltage | CRI        | Dimming         |
|------------|-------|-------------|-------------|-------------|---------------|------------|-----------------|
| MP030      | 7W    | 180mA       | 560 lm      | 15° 24° 36° | DC 48V        | ≥90<br>≥97 | Dali<br>0/1-10V |

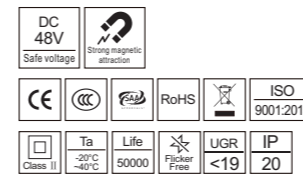
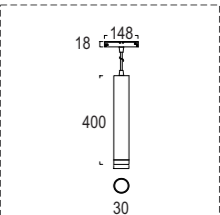

| Model Code | Power | LED Current | Lumen (±5%) | Beam angle  | Input voltage | CRI        | Dimming         |
|------------|-------|-------------|-------------|-------------|---------------|------------|-----------------|
| MP031      | 12W   | 300mA       | 1020 lm     | 15° 24° 36° | DC 48V        | ≥90<br>≥97 | Dali<br>0/1-10V |

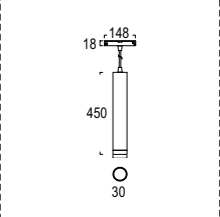

- **CCT:**  
2700K/3000K/3500K/4000K/5700K
- **Finish:**  
White/Black
- **Light source:**  
COB LED  
Luminus/CREE/Bridgelux



| Model Code | Power | LED Current | Lumen (±5%) | Beam angle  | Input voltage | CRI        | Dimming         |
|------------|-------|-------------|-------------|-------------|---------------|------------|-----------------|
| MF110      | 6W    | 160mA       | 450 lm      | 15° 24° 36° | DC 48V        | ≥90<br>≥97 | Dali<br>0/1-10V |

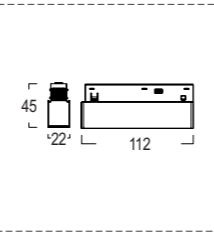

| Model Code | Power | LED Current | Lumen (±5%) | Beam angle  | Input voltage | CRI        | Dimming         |
|------------|-------|-------------|-------------|-------------|---------------|------------|-----------------|
| MF200      | 12W   | 300mA       | 950 lm      | 15° 24° 36° | DC 48V        | ≥90<br>≥97 | Dali<br>0/1-10V |

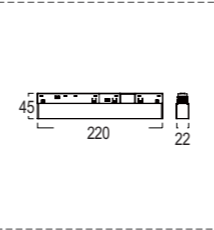

| Model Code | Power | LED Current | Lumen (±5%) | Beam angle  | Input voltage | CRI        | Dimming         |
|------------|-------|-------------|-------------|-------------|---------------|------------|-----------------|
| MF330      | 18W   | 450mA       | 1450 lm     | 15° 24° 36° | DC 48V        | ≥90<br>≥97 | Dali<br>0/1-10V |

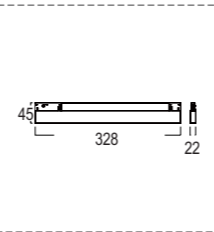

| Model Code | Power | LED Current | Lumen (±5%) | Beam angle  | Input voltage | CRI        | Dimming         |
|------------|-------|-------------|-------------|-------------|---------------|------------|-----------------|
| MD300      | 12W   | 300mA       | 950 lm      | 15° 24° 36° | DC 48V        | ≥90<br>≥97 | Dali<br>0/1-10V |

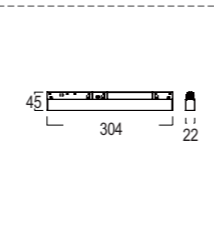

| Model Code | Power | LED Current | Lumen (±5%) | Beam angle  | Input voltage | CRI        | Dimming         |
|------------|-------|-------------|-------------|-------------|---------------|------------|-----------------|
| MD600      | 18W   | 450mA       | 1450 lm     | 15° 24° 36° | DC 48V        | ≥90<br>≥97 | Dali<br>0/1-10V |

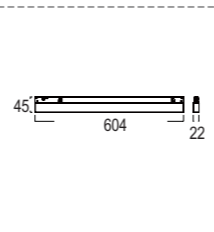

- CCT: 2700K/3000K/3500K/4000K/5700K
- Finish: White/Black
- Light source: SMD LED Osram/Sanar/Bridgelux

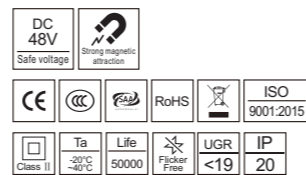

| Model Code | Power | LED Current | Lumen (±5%) | Beam angle  | Input voltage | CRI        | Dimming         |
|------------|-------|-------------|-------------|-------------|---------------|------------|-----------------|
| MZ110      | 6W    | 160mA       | 450 lm      | 15° 24° 36° | DC 48V        | ≥90<br>≥97 | Dali<br>0/1-10V |

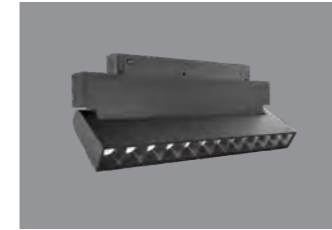
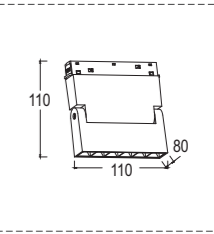

| Model Code | Power | LED Current | Lumen (±5%) | Beam angle  | Input voltage | CRI        | Dimming         |
|------------|-------|-------------|-------------|-------------|---------------|------------|-----------------|
| MZ220      | 12W   | 300mA       | 950 lm      | 15° 24° 36° | DC 48V        | ≥90<br>≥97 | Dali<br>0/1-10V |

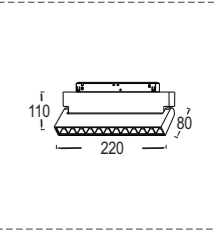

| Model Code | Power | LED Current | Lumen (±5%) | Beam angle | Input voltage | CRI        | Dimming         |
|------------|-------|-------------|-------------|------------|---------------|------------|-----------------|
| MT300      | 24W   | 600mA       | 1950 lm     | 120°       | DC 48V        | ≥90<br>≥97 | Dali<br>0/1-10V |

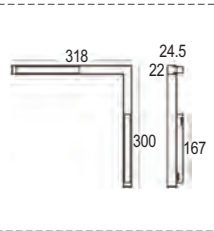

- CCT: 2700K/3000K/3500K/4000K/5700K
- Finish: White/Black
- Light source: SMD LED Osram/Sanar/Bridgelux

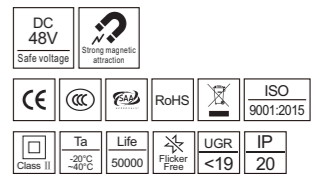



| Model Code | Power | LED Current | Lumen (±5%) | Beam angle  | Input voltage | CRI        | Dimming         |
|------------|-------|-------------|-------------|-------------|---------------|------------|-----------------|
| MA100      | 6W    | 160mA       | 420 lm      | 15° 24° 36° | DC 48V        | ≥90<br>≥97 | Dali<br>0/1-10V |

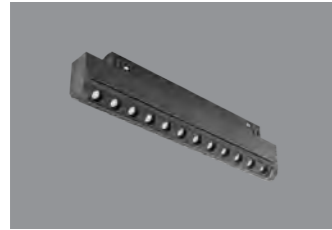
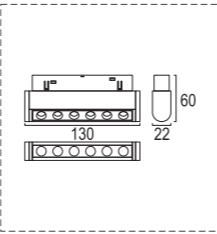

| Model Code | Power | LED Current | Lumen (±5%) | Beam angle  | Input voltage | CRI        | Dimming         |
|------------|-------|-------------|-------------|-------------|---------------|------------|-----------------|
| MA200      | 12W   | 300mA       | 840 lm      | 15° 24° 36° | DC 48V        | ≥90<br>≥97 | Dali<br>0/1-10V |

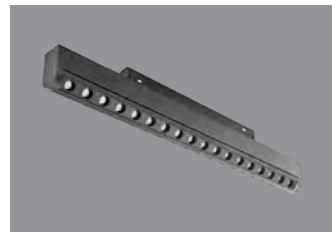
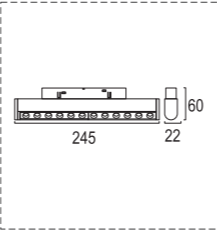

| Model Code | Power | LED Current | Lumen (±5%) | Beam angle  | Input voltage | CRI        | Dimming         |
|------------|-------|-------------|-------------|-------------|---------------|------------|-----------------|
| MA300      | 18W   | 450mA       | 1260 lm     | 15° 24° 36° | DC 48V        | ≥90<br>≥97 | Dali<br>0/1-10V |

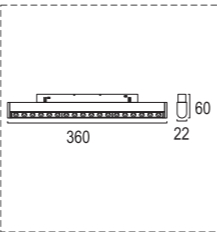

| Model Code | Power | LED Current | Lumen (±5%) | Beam angle  | Input voltage | CRI        | Dimming         |
|------------|-------|-------------|-------------|-------------|---------------|------------|-----------------|
| MA400      | 24W   | 600mA       | 1680 lm     | 15° 24° 36° | DC 48V        | ≥90<br>≥97 | Dali<br>0/1-10V |

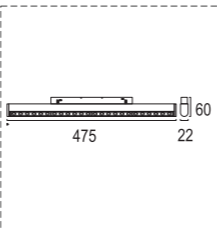

| Model Code | Power | LED Current | Lumen (±5%) | Beam angle  | Input voltage | CRI        | Dimming         |
|------------|-------|-------------|-------------|-------------|---------------|------------|-----------------|
| MA500      | 30W   | 700mA       | 3360 lm     | 15° 24° 36° | DC 48V        | ≥90<br>≥97 | Dali<br>0/1-10V |

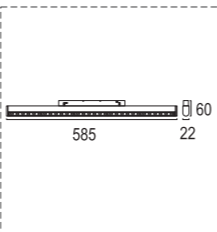

- CCT: 2700K/3000K/3500K/4000K/5700K
- Finish: White/Black
- Light source: SMD LED  
Osram/Sanar/Bridgelux

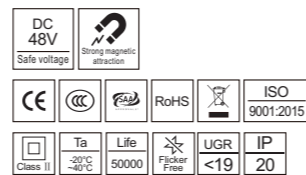

| Model Code | Power | LED Current | Lumen (±5%) | Beam angle  | Input voltage | CRI        | Dimming         |
|------------|-------|-------------|-------------|-------------|---------------|------------|-----------------|
| MX06       | 6W    | 160mA       | 420 lm      | 15° 24° 36° | DC 48V        | ≥90<br>≥97 | Dali<br>0/1-10V |

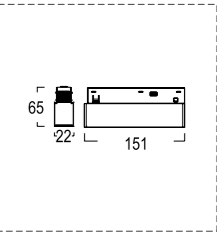

| Model Code | Power | LED Current | Lumen (±5%) | Beam angle  | Input voltage | CRI        | Dimming         |
|------------|-------|-------------|-------------|-------------|---------------|------------|-----------------|
| MX12       | 12W   | 300mA       | 840 lm      | 15° 24° 36° | DC 48V        | ≥90<br>≥97 | Dali<br>0/1-10V |

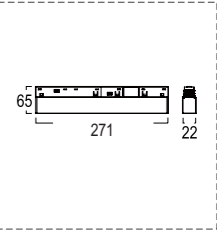

| Model Code | Power | LED Current | Lumen (±5%) | Beam angle  | Input voltage | CRI        | Dimming         |
|------------|-------|-------------|-------------|-------------|---------------|------------|-----------------|
| MX18       | 18W   | 450mA       | 1260 lm     | 15° 24° 36° | DC 48V        | ≥90<br>≥97 | Dali<br>0/1-10V |

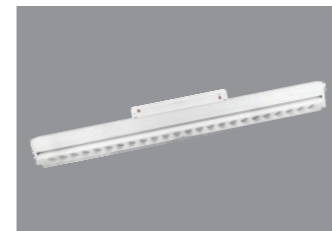
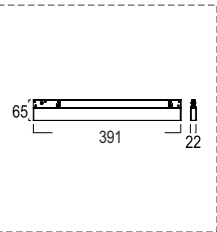

| Model Code | Power | LED Current | Lumen (±5%) | Beam angle  | Input voltage | CRI        | Dimming         |
|------------|-------|-------------|-------------|-------------|---------------|------------|-----------------|
| MX24       | 24W   | 600mA       | 1680 lm     | 15° 24° 36° | DC 48V        | ≥90<br>≥97 | Dali<br>0/1-10V |

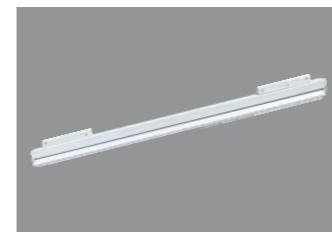
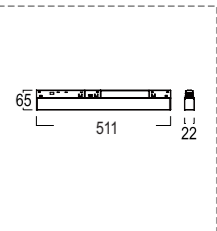

| Model Code | Power | LED Current | Lumen (±5%) | Beam angle  | Input voltage | CRI        | Dimming         |
|------------|-------|-------------|-------------|-------------|---------------|------------|-----------------|
| MX48       | 48W   | 1200mA      | 3360 lm     | 15° 24° 36° | DC 48V        | ≥90<br>≥97 | Dali<br>0/1-10V |

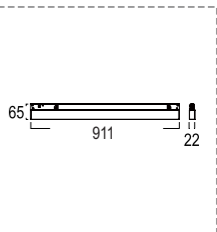

- CCT: 2700K/3000K/3500K/4000K/5700K
- Finish: White/Black
- Light source: SMD LED  
Osram/Sanar/Bridgelux

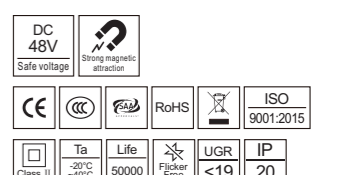



| Model Code | Power | LED Current | Lumen (±5%) | Beam angle | Input voltage | CRI        | Dimming         |
|------------|-------|-------------|-------------|------------|---------------|------------|-----------------|
| MS028      | 3W    | 300mA       | 45 lm       | 18° ~ 35°  | DC 48V        | ≥90<br>≥97 | Dali<br>0/1-10V |

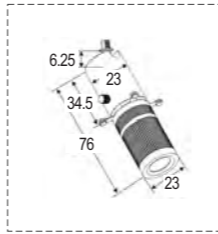

| Model Code | Power | LED Current | Lumen (±5%) | Beam angle | Input voltage | CRI        | Dimming         |
|------------|-------|-------------|-------------|------------|---------------|------------|-----------------|
| MS038      | 5W    | 120mA       | 200 lm      | 18° ~ 35°  | DC 48V        | ≥90<br>≥97 | Dali<br>0/1-10V |

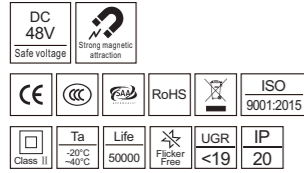
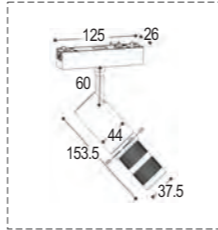

- **Swivel angle:**
- **CCT:**  
2700K/3000K/3500K/4000K/5700K
- **Finish:**  
White/Black
- **Light source:**  
COB LED  
Luminus/CREE/Bridgelux



| Model Code | Power | LED Current | Lumen (±5%) | Beam angle      | Input voltage | CRI        | Dimming         |
|------------|-------|-------------|-------------|-----------------|---------------|------------|-----------------|
| MP072      | 6W+2W | 180mA       | 400 lm      | 15° 24° 38° 45° | DC 48V        | ≥90<br>≥97 | Dali<br>0/1-10V |

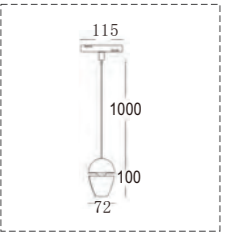

| Model Code | Power | LED Current | Lumen (±5%) | Beam angle | Input voltage | CRI        | Dimming         |
|------------|-------|-------------|-------------|------------|---------------|------------|-----------------|
| MP100      | 10W   | 250mA       | 400 lm      | 38° 60°    | DC 48V        | ≥90<br>≥97 | Dali<br>0/1-10V |

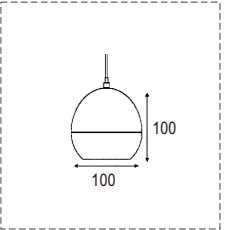

| Model Code | Power | LED Current | Lumen (±5%) | Beam angle | Input voltage | CRI        | Dimming         |
|------------|-------|-------------|-------------|------------|---------------|------------|-----------------|
| MS100      | 10W   | 250mA       | 400 lm      | 15° ~ 60°  | DC 48V        | ≥90<br>≥97 | Dali<br>0/1-10V |

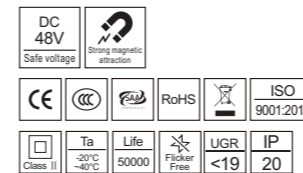
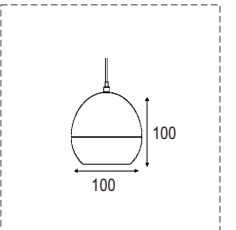

- **CCT:**  
2700K/3000K/3500K/4000K/5700K
- **Finish:**  
White/Black
- **Light source:**  
COB LED  
Luminus/CREE/Bridgelux



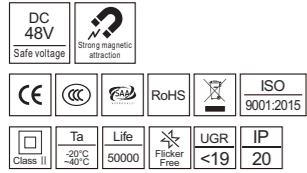

- **Swivel angle:**  
355° / 90°
- **CCT:**  
2700K/3000K/3500K/4000K/5700K
- **Finish:**  
White/Black
- **Light source:**  
COB LED  
Luminus/Bridgelux

| Model Code | Power | LED Current | Lumen (±5%) | Beam angle | Input voltage | CRI        | Dimming         |  |
|------------|-------|-------------|-------------|------------|---------------|------------|-----------------|--|
| MZ035      | 5W    | 120mA       | 270lm       | 15° ~ 50°  | DC 48V        | ≥90<br>≥97 | Dali<br>0/1-10V |  |
| MZ045      | 8W    | 180mA       | 470lm       | 15° ~ 50°  | DC 48V        | ≥90<br>≥97 | Dali<br>0/1-10V |  |
| MZ055      | 12W   | 300mA       | 720lm       | 15° ~ 50°  | DC 48V        | ≥90<br>≥97 | Dali<br>0/1-10V |  |
| MZ065      | 18W   | 450mA       | 1050lm      | 15° ~ 50°  | DC 48V        | ≥90<br>≥97 | Dali<br>0/1-10V |  |
| MZ075      | 25W   | 600mA       | 1600lm      | 15° ~ 50°  | DC 48V        | ≥90<br>≥97 | Dali<br>0/1-10V |  |
| MZ085      | 30W   | 750mA       | 2100lm      | 15° ~ 50°  | DC 48V        | ≥90<br>≥97 | Dali<br>0/1-10V |  |

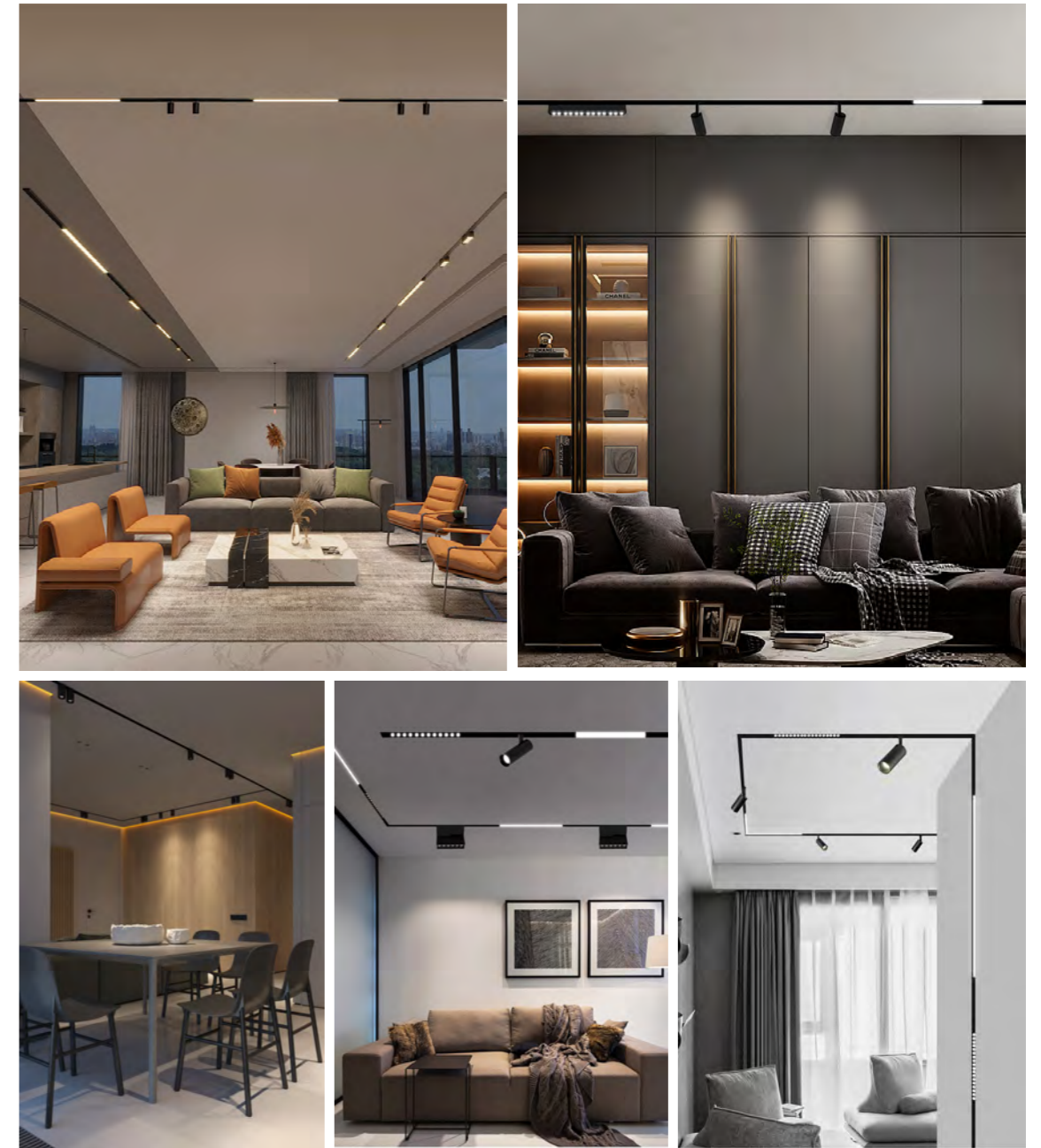

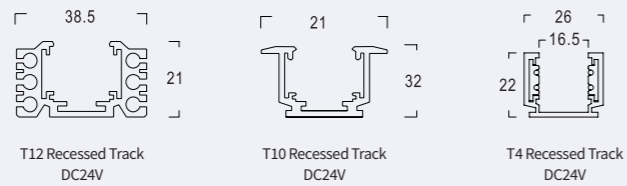
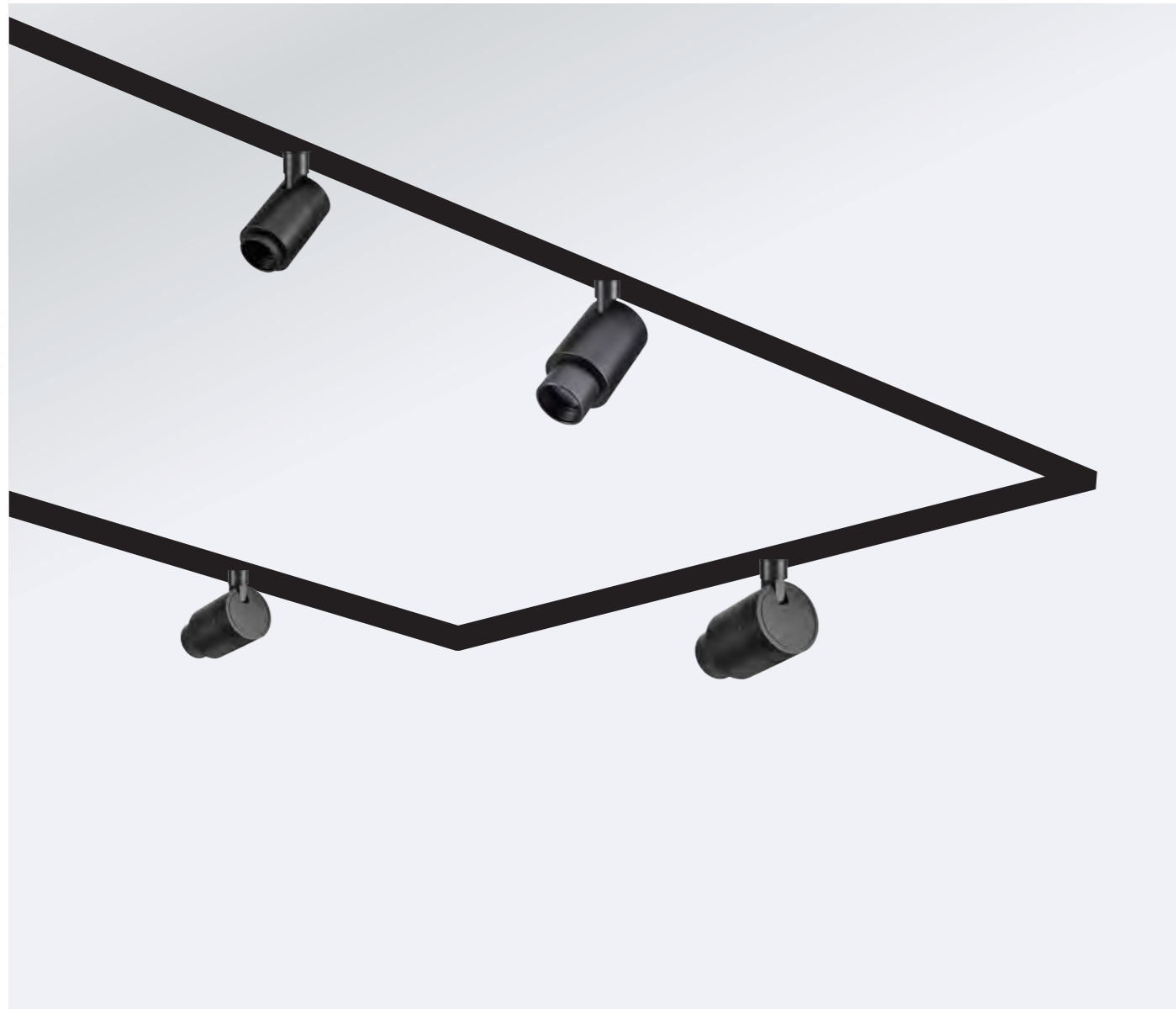

Zoom to adjust the beam angle



| Model Code | Power | LED Current | Lumen (±5%) | Beam angle | Input voltage    | CRI        | Dimming         |
|------------|-------|-------------|-------------|------------|------------------|------------|-----------------|
| KT501      | 1W    | 350mA       | 25 lm       | 8° ~ 30°   | DC 12V<br>DC 48V | ≥90<br>≥97 | Dali<br>0/1-10V |

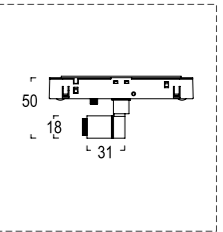

| Model Code | Power | LED Current | Lumen (±5%) | Beam angle | Input voltage    | CRI        | Dimming         |
|------------|-------|-------------|-------------|------------|------------------|------------|-----------------|
| KT503      | 3W    | 700mA       | 40 lm       | 8° ~ 40°   | DC 12V<br>DC 48V | ≥90<br>≥97 | Dali<br>0/1-10V |

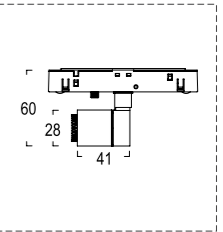

| Model Code | Power | LED Current | Lumen (±5%) | Beam angle            | Input voltage    | CRI        | Dimming         |
|------------|-------|-------------|-------------|-----------------------|------------------|------------|-----------------|
| KT505      | 5W    | 120mA       | 50 lm       | 8° ~ 35°<br>10° ~ 40° | DC 24V<br>DC 48V | ≥90<br>≥97 | Dali<br>0/1-10V |

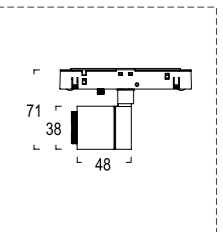

| Model Code | Power | LED Current | Lumen (±5%) | Beam angle  | Input voltage    | CRI        | Dimming         |
|------------|-------|-------------|-------------|-------------|------------------|------------|-----------------|
| KT5032     | 3W    | 700mA       | 145 lm      | 15° 24° 36° | DC 24V<br>DC 48V | ≥90<br>≥97 | Dali<br>0/1-10V |

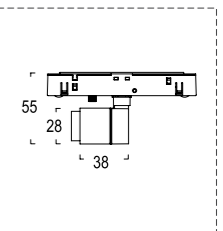

| Model Code | Power | LED Current | Lumen (±5%) | Beam angle  | Input voltage    | CRI        | Dimming         |
|------------|-------|-------------|-------------|-------------|------------------|------------|-----------------|
| KT5052     | 5W    | 120mA       | 250 lm      | 15° 24° 36° | DC 24V<br>DC 48V | ≥90<br>≥97 | Dali<br>0/1-10V |

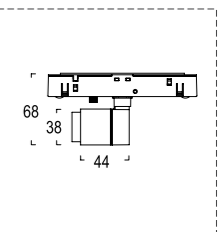

- CCT: 2700K/3000K/3500K/4000K/5700K
- Finish: White/Black
- Light source: COB LED  
Luminus/CREE/Bridgelux

|                        |                        |                        |                            |
|------------------------|------------------------|------------------------|----------------------------|
| DC 12V<br>Safe voltage | DC 24V<br>Safe voltage | DC 48V<br>Safe voltage | Strong magnetic attraction |
| CE                     | CCC                    | RoHS                   | ISO 9001:2015              |
| Class II               | Ta -20°C ~ -40°C       | Life 50000             | UGR Flicker Free <19       |
|                        |                        |                        | IP 20                      |

Pre-bury recessed system

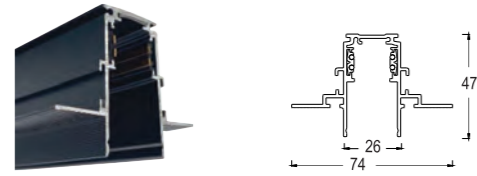

Live end L

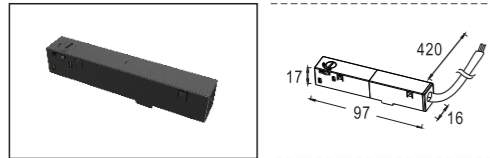

Live end R

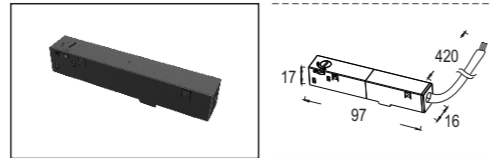

L Joint

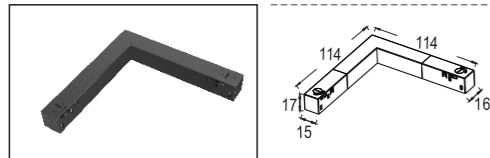

Turning joint

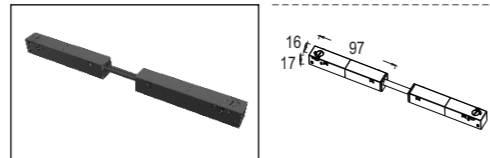

I Joint

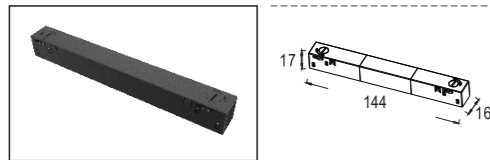

L Joint

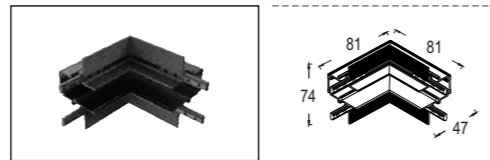

L Joint(L)

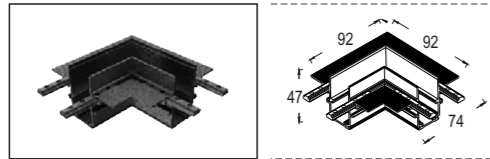

L Joint(R)

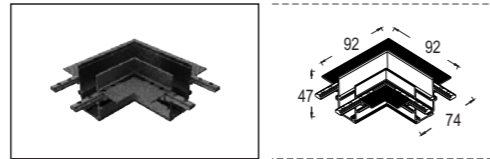

End Cover

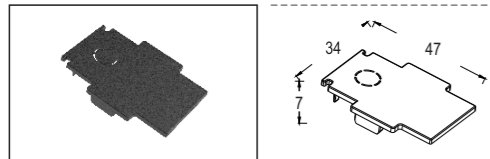

Pendant accessory



Surface mounted system

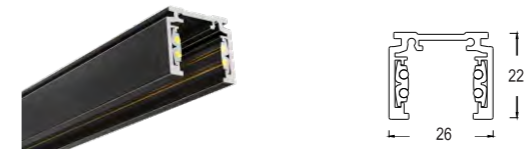

Live end L

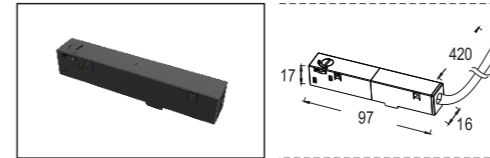

Live end R

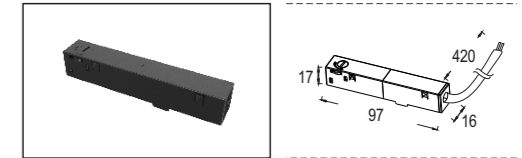

L Joint

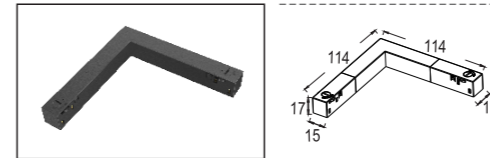

Turning joint

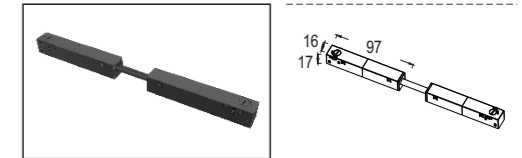

I Joint

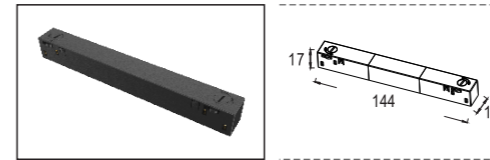

L Joint

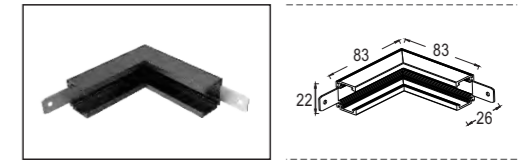

L Joint(L)

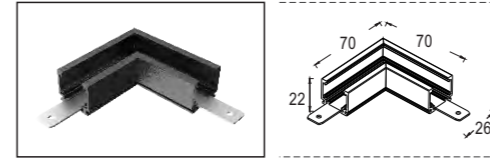

L Joint(R)

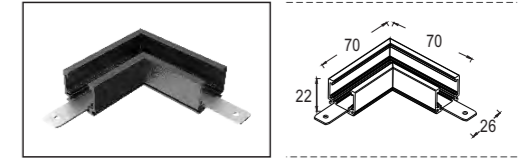

Cover

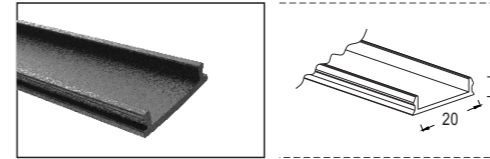

End Cover

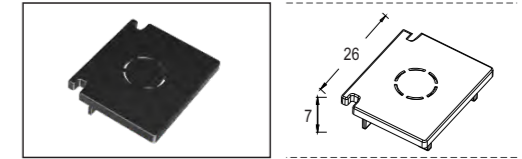

Pendant system

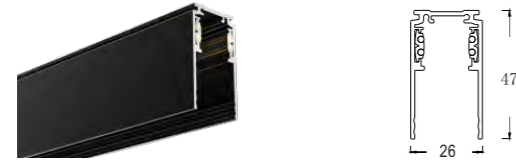

Live end L

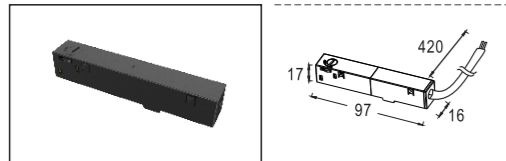

Live end R

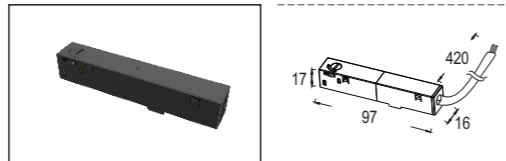

L Joint

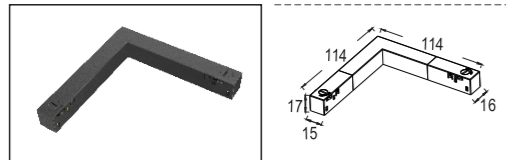

Turning joint

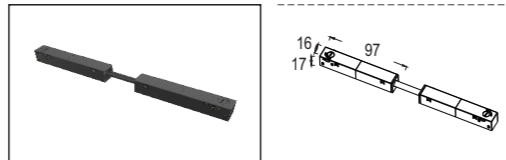

I Joint

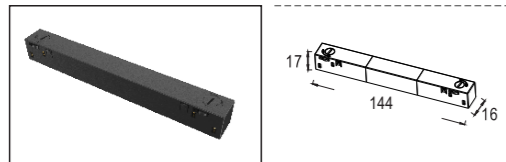

L Joint

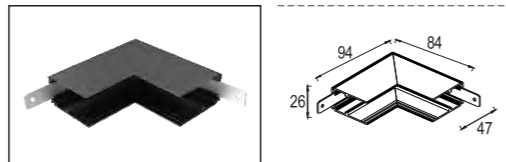

L Joint(L)

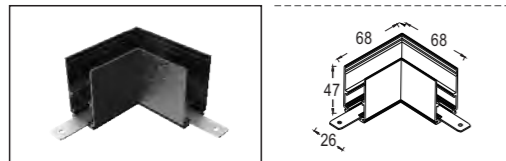

L Joint(R)

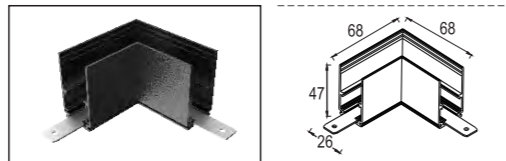

End Cover

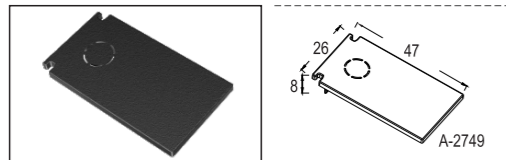

Trimless recessed system

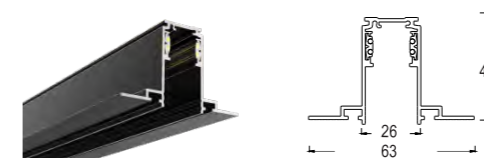

Live end L

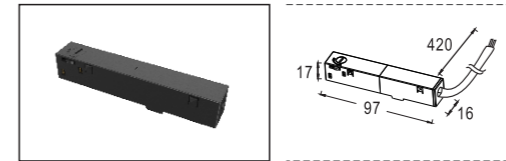

Live end R

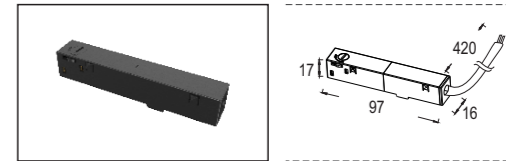

L Joint

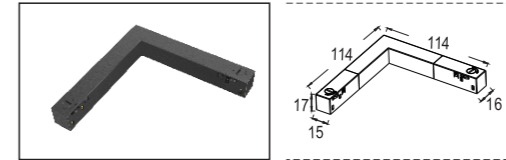

Turning joint

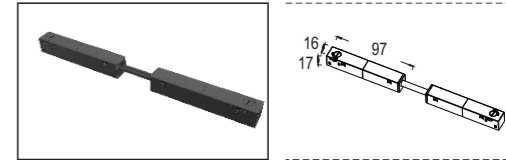

I Joint

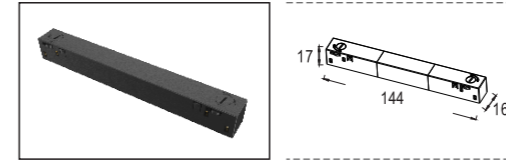

L Joint

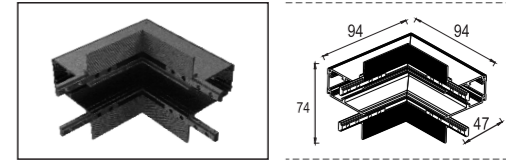

L Joint(L)

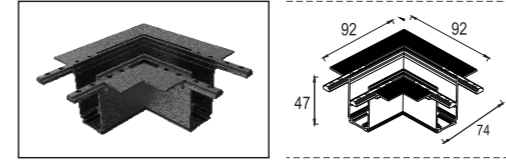

L Joint(R)

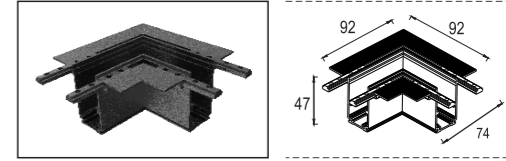

End Cover

